

User Manual



cMT-SVR Startup Guide

Table of Contents

Chapter 1 Overview	1
1.1 Specification	1
1.2 Dimensions	2
1.3 Connector pin designations	4
1.4 USB host port and SD card slot	4
1.5 Ethernet port	4
1.6 DIP switch	4
1.7 LED indicator	5
1.8 Lithium battery	5
1.9 Power connection	5
1.10 How to update cMT-SVR OS image	5
Chapter 2 System Setting	7
2.1 cMT-SVR System Setting	8
2.1.1 Information	8
2.1.2 System Setting	9
Chapter 3 How to create a cMT-SVR project	16
3.1 Create a new project	16
3.2 Download project to cMT-SVR	17
Chapter 4 cMT Viewer App	18
4.1 Introduction of icons	18
4.2 How to load project file to cMT Viewer	19
4.3 How to open cMT Viewer settings page	22
4.4 Monitor Mode	28

Chapter 1 Overview

1.1 Specification

Features			
		cMT-SVR-100/102	cMT-SVR-200/202
Memory	Flash	256 MB	256 MB
	RAM	256 MB	256 MB
Processor		32-bit RISC 600MHz	32-bit RISC 600MHz
I/O Port	SD Card Slot	SD/SDHC	SD/SDHC
	USB Host	USB 2.0 x 1	USB 2.0 x 1
	USB Client	N/A	N/A
	Ethernet	10/100/1000 Base-T x 2	10/100/1000 Base-T x 1
	Wi-Fi	N/A	IEEE 802.11 b/g/n 802.11b: max 18.01 dBm 802.11g: max 11.02 dBm 802.11n: max 12.20 dBm
	COM Port	COM1: RS-232 COM2: RS-485 2W/4W COM3: RS-485 2W	COM1: RS-232 COM2: RS-485 2W/4W COM3: RS-485 2W
RTC		Built-in	Built-in
Power	Input Power	24±20%VDC	10.5~28VDC
	Power Isolation	Built-in	Built-in
	Power Consumption	230mA@24VDC	1000mA@12VDC ; 450mA@24VDC
	Voltage Resistance	500VAC (1 Minute)	500VAC (1 Minute)
	Isolation Resistance	Exceed 50MΩ at 500VDC	Exceed 50MΩ at 500VDC
	Vibration Endurance	10 to 25Hz (X, Y, Z direction 2G 30 minutes)	10 to 25Hz (X, Y, Z direction 2G 30 minutes)
Specification	PCB Coating	Yes	Yes
	Enclosure	Plastic	Plastic
	Dimensions WxHxD	27 x 130 x 115 mm	27 x 130 x 115 mm
	Weight	Approx. 0.18 kg	Approx. 0.18 kg
	Mount	35 mm DIN rail mounting	35 mm DIN rail mounting
Environment	Protection Structure	IP20	IP20
	Storage Temperature	-20° ~ 70°C (-4° ~ 158°F)	-20° ~ 70°C (-4° ~ 158°F)
	Operating Temperature	-20° ~ 55°C (-4° ~ 131°F)	-10° ~ 55°C (14° ~ 131°F)
	Relative Humidity	10% ~ 90% (non-condensing)	10% ~ 90% (non-condensing)

1.2 Dimensions
cMT-SVR-100/102

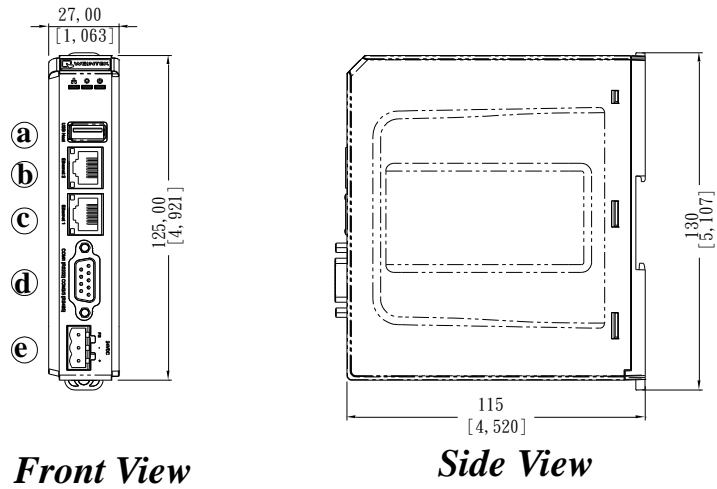

Front View

Side View

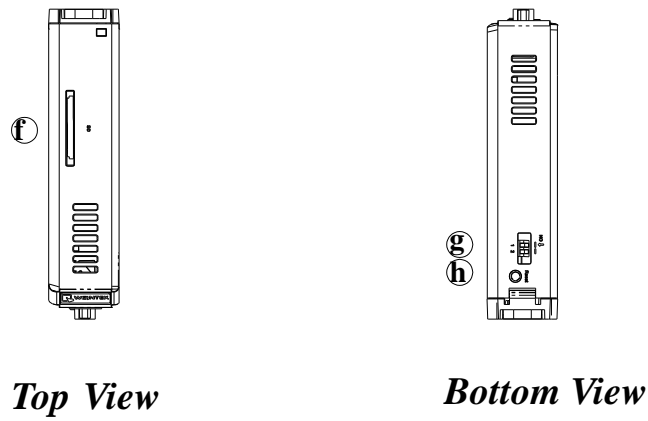

Top View

Bottom View

a	USB Host Port	e	Power Connector
b	Ethernet 2 Port	f	SD Card Slot
c	Ethernet 1 Port	g	DIP Switch
d	COM1 RS-232, COM2 RS-485 2W/4W, COM3 RS-485 2W	h	Reset Button

cMT-SVR-200/202

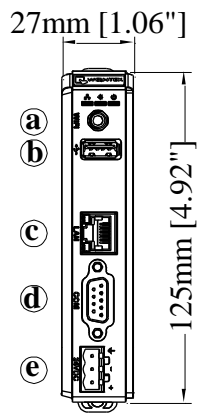

Front View

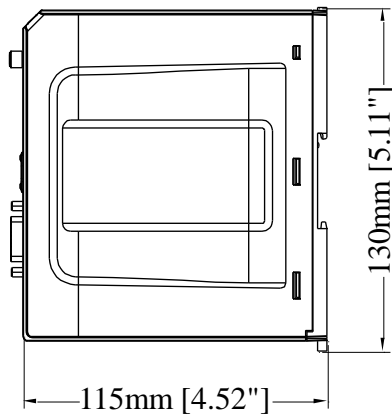

Side View

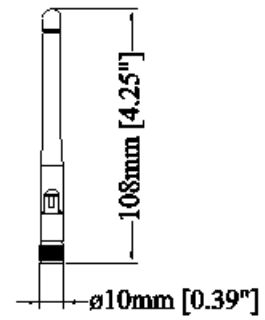

Antenna

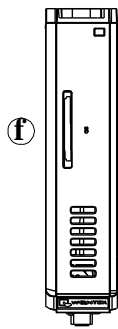

Top View

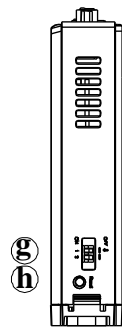

Bottom View

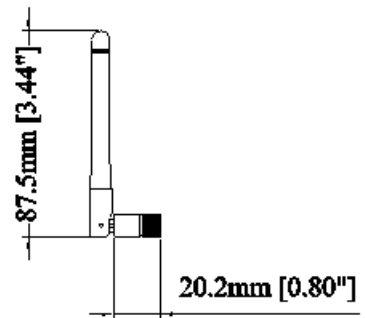

a	Wi-Fi	e	Power Connector
b	USB Host Port	f	SD Card Slot
c	Ethernet Port	g	DIP Switch
d	COM1 RS-232, COM2 RS-485 2W/4W, COM3 RS-485 2W	h	Reset Button

1.3 Connector pin designations

PIN#	COM1 RS-232	COM2 RS-485		COM3 RS-485
		2W	4W	
1				Data+
2	RxD			
3	TxD			
4				Data-
5	Ground			
6		Data+	RX+	
7		Data-	RX-	
8			TX+	
9			TX-	

1.4 USB host port and SD card slot

USB 2.0 full speed host interface supports barcode scanners and USB drive. While using external hard drive, use external power supply. Do not use USB port to charge external device. You may use SD card as an expansion of storage.

1.5 Ethernet port

The unit has one/two 10/100/1000M Gigabit Ethernet ports.

The LED indicators on the Ethernet port indicate:

Orange LED: LAN link status

Green LED: Active communication status

1.6 DIP switch

Each unit is equipped with a reset button and a set of DIP switches. When using the DIP switches to change modes, the corresponding functions will be triggered.

When SW1 is turned ON and power the unit again, the IP setting is restored to default:

cMT-SVR-100/102

Ethernet 1: DHCP

Ethernet 2: 192.168.100.1

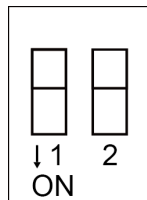

cMT-SVR-200/202

Ethernet 1: DHCP

Wi-Fi: DHCP

SW1	SW2	Mode
OFF	OFF	Normal mode
ON	OFF	Restore Ethernet IP settings
OFF	ON	Boot loader mode
ON	ON	Restore factory default

Note: Reboot cMT-SVR after adjusting DIP switches to start the corresponding mode. When restore factory default, the project file and history data stored in the unit are all cleared.

1.7 LED indicator

LED indicators show the operation status of cMT-SVR.

Power (Orange)	Indicates power status.
CPU (Green)	Indicates CPU status.
Communication (Blue)	Indicates communication status. It flashes during communication and may stay on when communication is good.

1.8 Lithium battery

A cMT-SVR Series HMI requires a CR1225/CR1220 coin type lithium battery to keep the RTC running. Due to the difference in manufacturing time, the battery type can either be CR1225 or CR1220 3V lithium battery. To change the battery, please choose the type depending on the model you use.

1.9 Power connection

Power: The unit can be powered by DC power only, cMT-SVR-100/102 voltage range: 24±20% Volts DC, cMT-SVR-200/202 voltage range: 10.5~28 Volts DC, compatible with most controller DC systems.

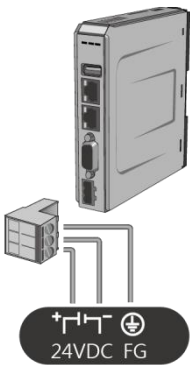

Note: Connect positive DC line to the ‘+’ terminal and the DC ground to the ‘-’ terminal.

1.10 How to update cMT-SVR OS image

Copy the MTfirmware.bin file to SD card, insert the SD card to cMT-SVR and flip DIP Switch 2 to ON. Restart cMT-SVR and wait about 2 minutes for the system to update OS image. To find the version number of cMT-SVR OS, please log in System Setting as shown below. (Details can be found in later chapters.)

Browser window: cMT series Server x | nicolas | 192.168.1.118/web_ihmi/Setipframe.php

identity: System Setting | Logout | cMT-4B20 | 2017/03/10 | 02:06:19 pm

- Network
- Date/Time
- HMI Name
- History
- Email
- Project Management
- System Password
- Enhanced Security
- EasyAccess 2.0

Network

Ethernet

Ethernet1 (WAN/LAN) Ethernet2 (LAN)
MAC address : 00:0c:26:04:4b:20 MAC address : 00:0c:26:04:4b:e8

IP Address

Obtain IP address automatically

Use static IP address below(Eth1)

IP:	192 . 168 . 1 . 118
Mask:	255 . 255 . 252 . 0
Gateway:	192 . 168 . 1 . 254
DNS:	139 . 175 . 55 . 244

★ Current OS version:
cMT-SVR OS build
20151127

Chapter 2 System Setting

Connect cMT-SVR via Ethernet cable or Wi-Fi, and configure system settings using the following two ways.

Set in internet browser

Open internet browser (IE, Chrome, or Firefox), and enter cMT-SVR IP address (for example: 192.168.1.15/web_ihmi) to configure cMT-SVR.

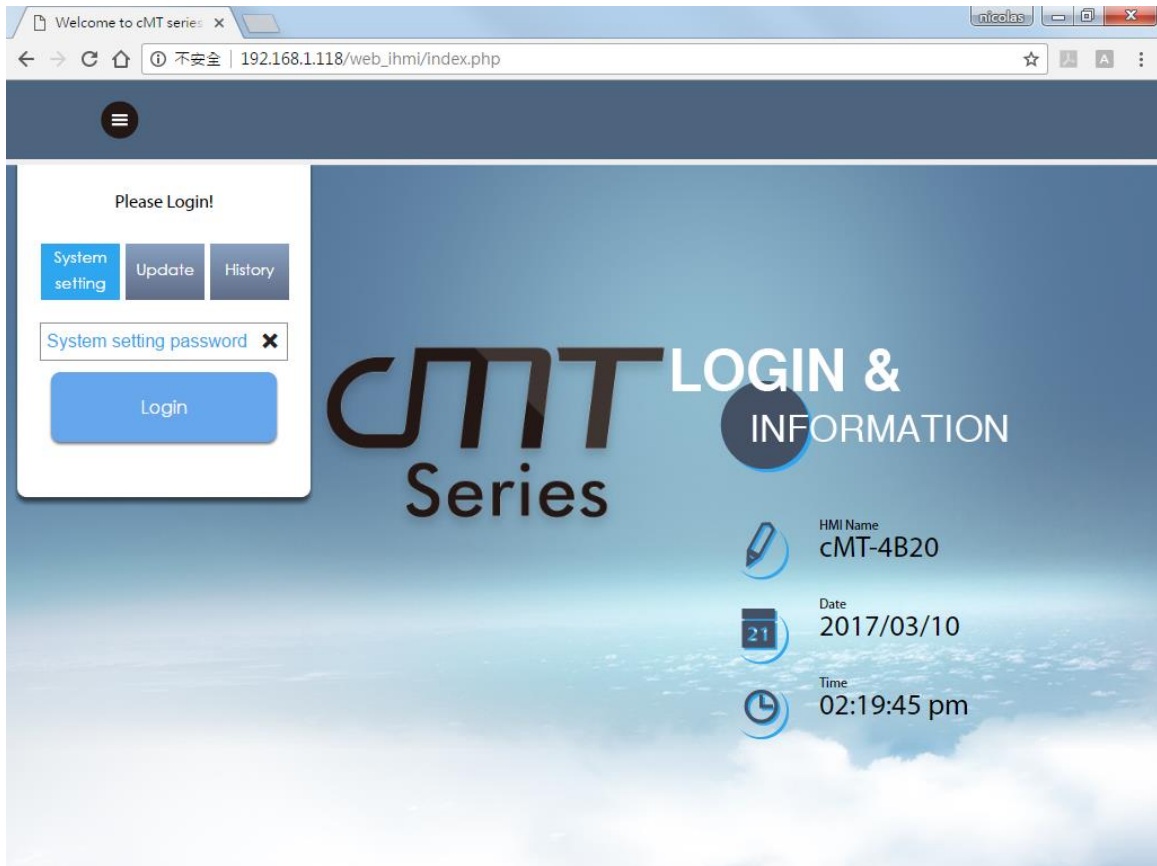

Set on cMT Viewer devices

Launch cMT Viewer App, tap Search, select the cMT-SVR and tap  icon to configure.

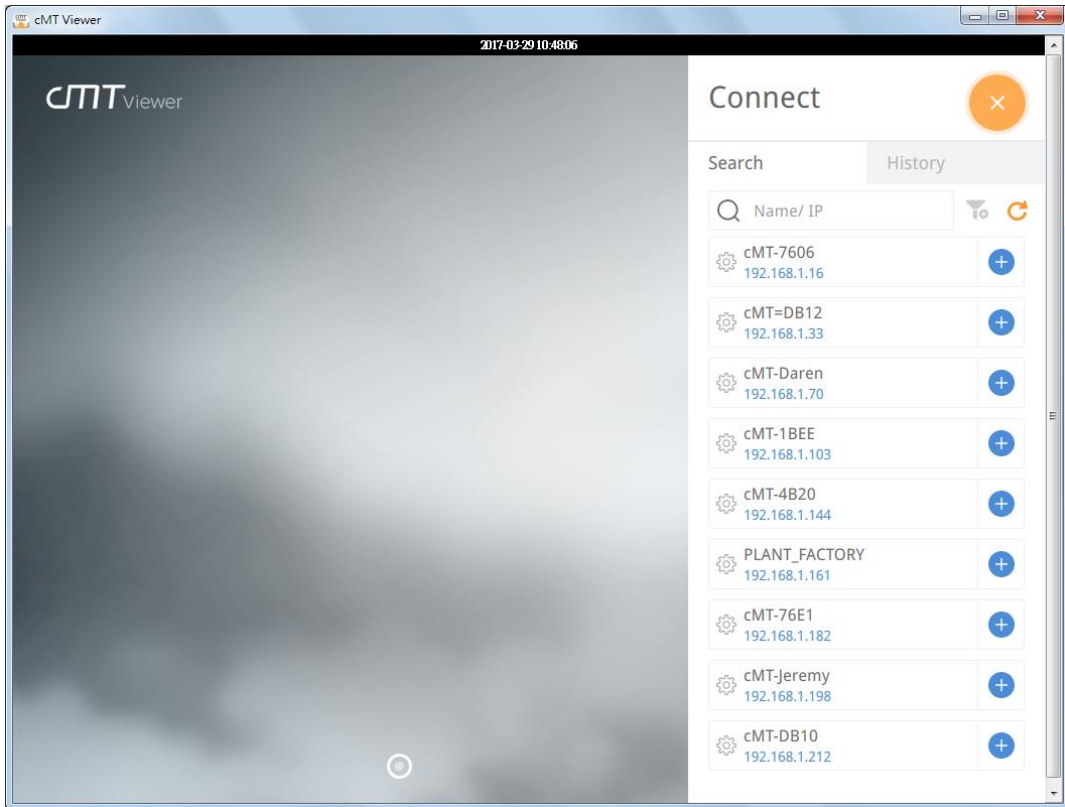



2.1 cMT-SVR System Setting

2.1.1 Information

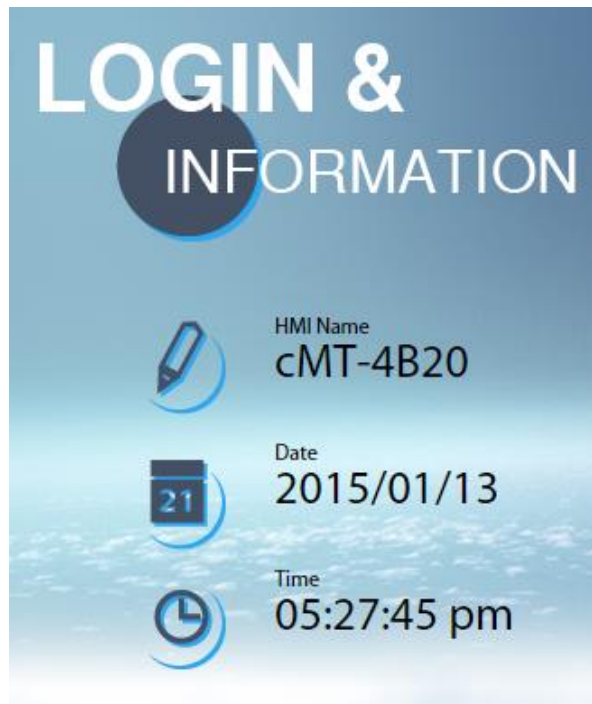
The following part introduces cMT-SVR system information.



Icon	Description
	Displays HMI name.
	Displays current date.
	Displays current time.

2.1.2 System Setting

The following part introduces cMT-SVR system setting.

Please Login!

System
setting

Update

History

Login

There are two modes, [System setting] and [Update]. [System Setting] controls all the settings while [Update] controls limited items. For safety, specify password for configuration. Enter password to log in and then select [History] to back up history data.

Network

Set the IP address of Ethernet port. cMT-SVR-100/102 has two Ethernet ports while cMT-SVR-200/202 only has one.

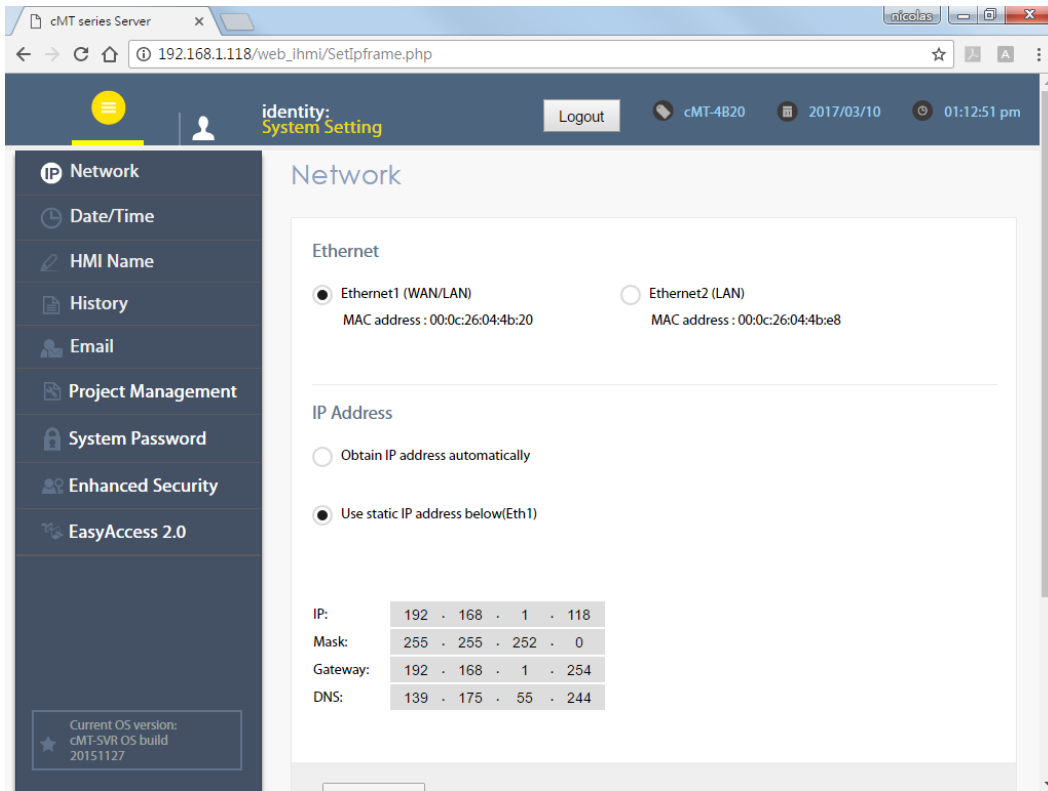

Wi-Fi

cMT-SVR-200/202 can be connected via Wi-Fi. The settings page is shown below.

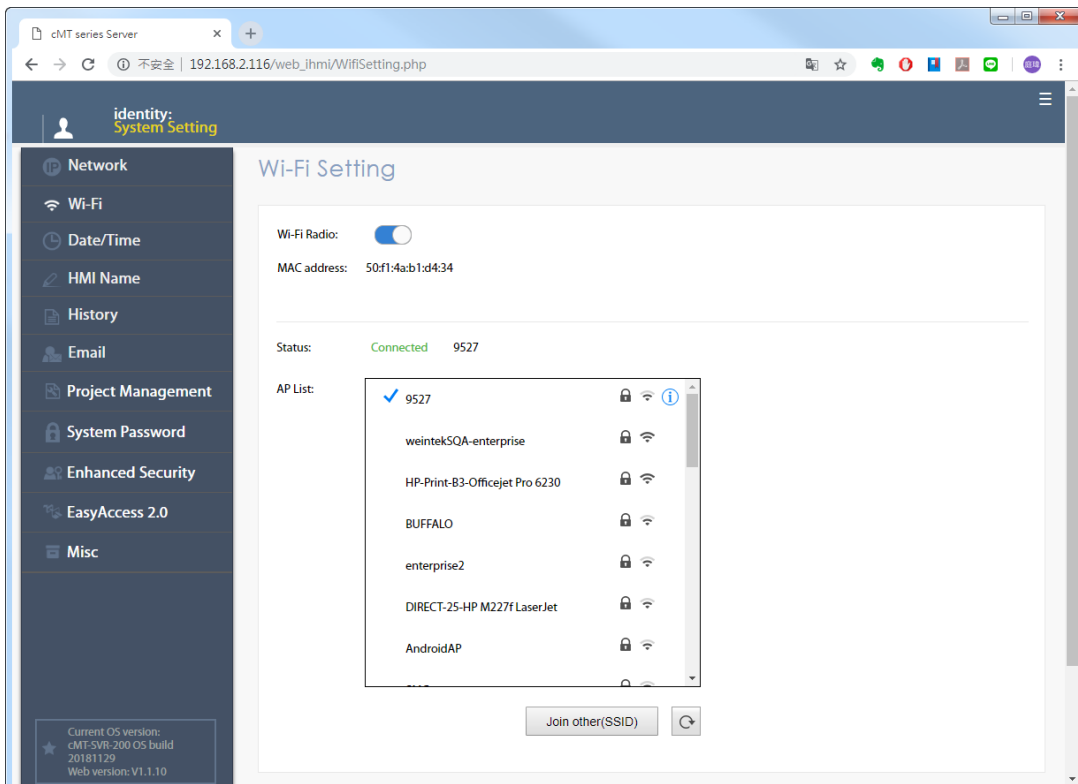

Date/Time

Set time, or select [Sync with host.] to synchronize cMT-SVR time with PC time.

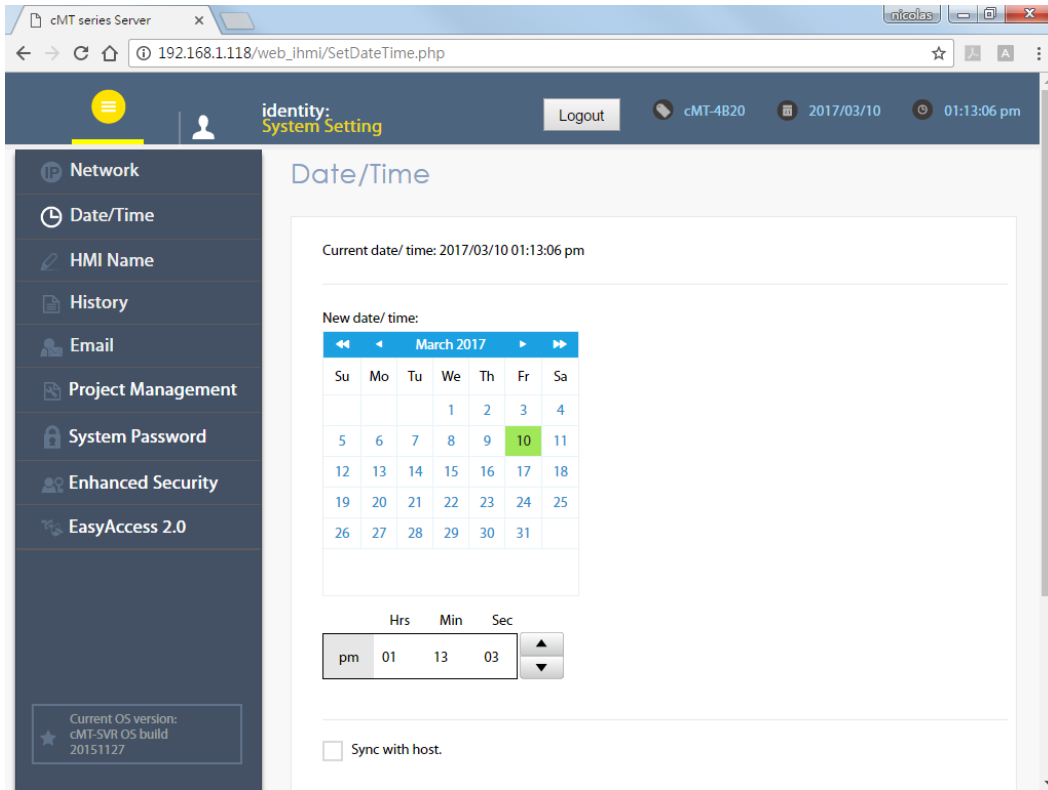

HMI Name

Enter a cMT-SVR name to identify the unit. This saves the trouble of remembering the IP address of each unit. Click [Identification light] button to turn on the CPU light of the unit. The light flashes 3 times to help finding the unit.

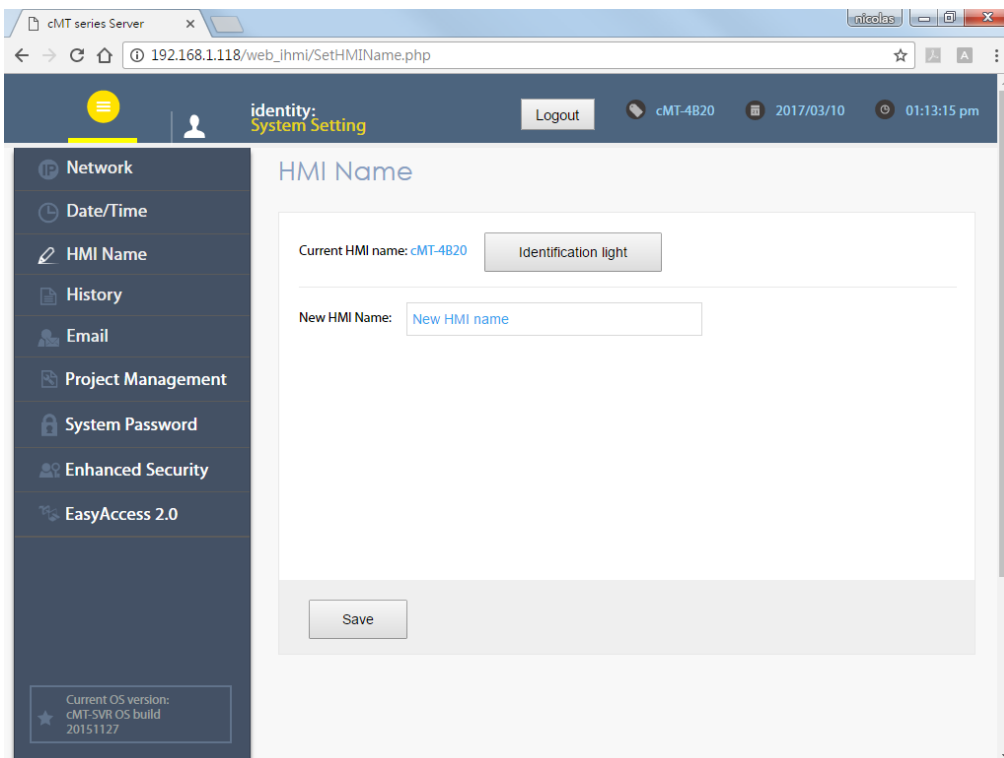

History

Clear or backup history data in cMT-SVR.

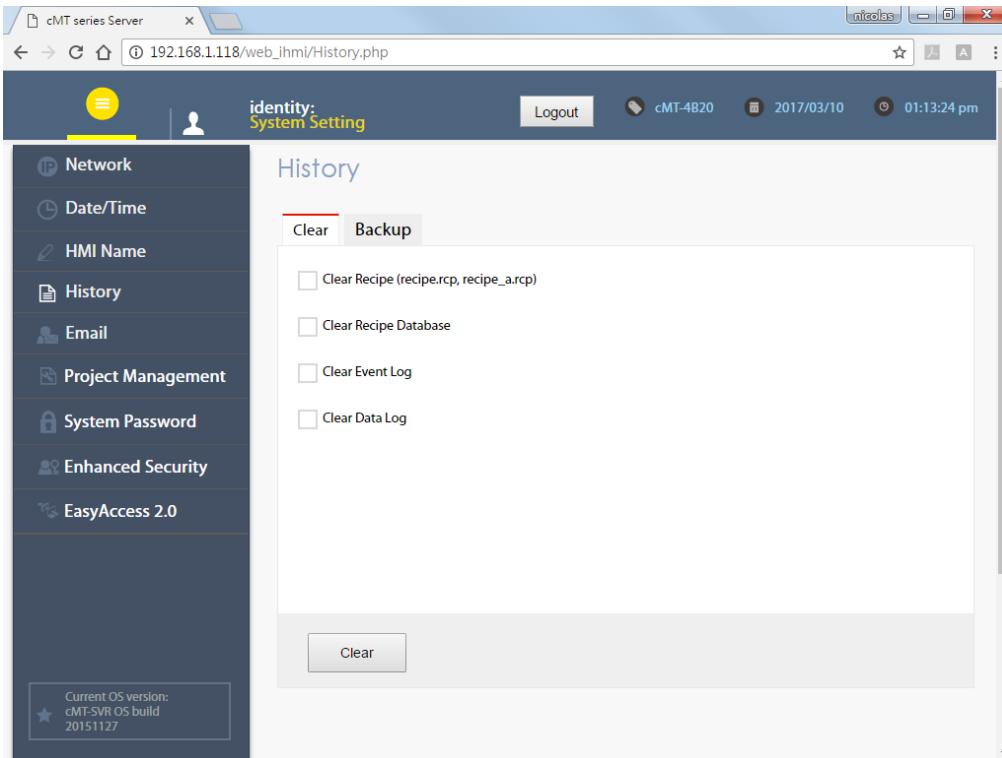

Email

Set the mail address and contact group.

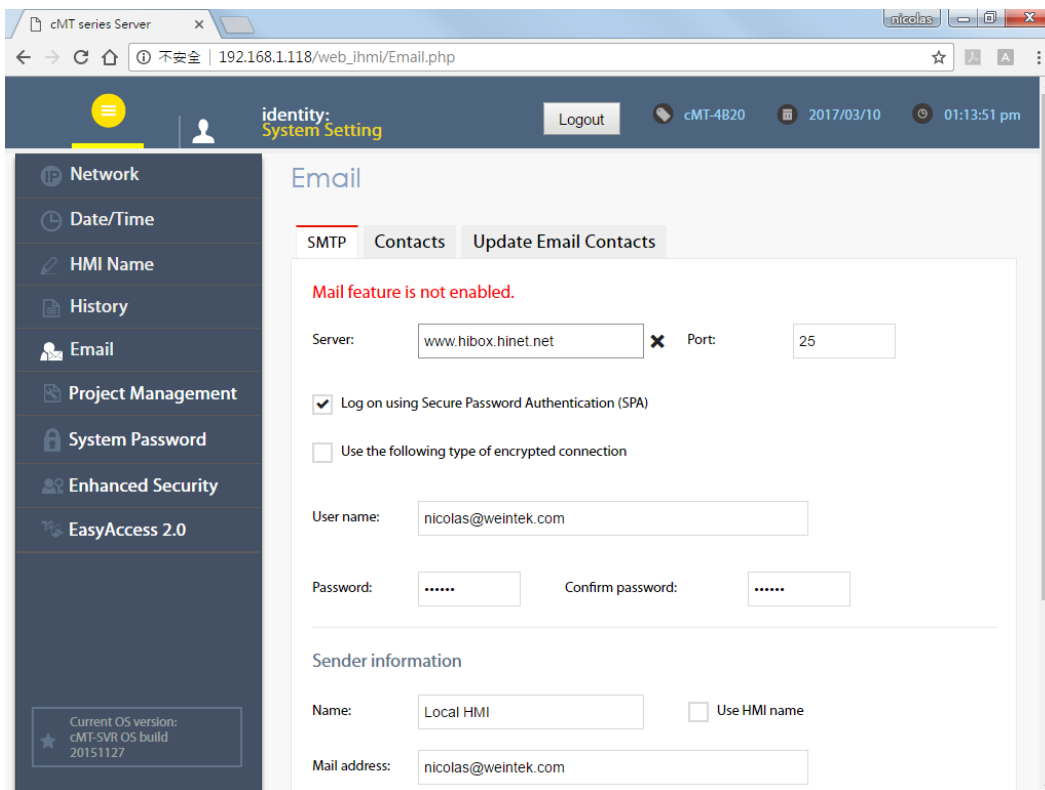

Project Management

Restart, update, or backup project file.

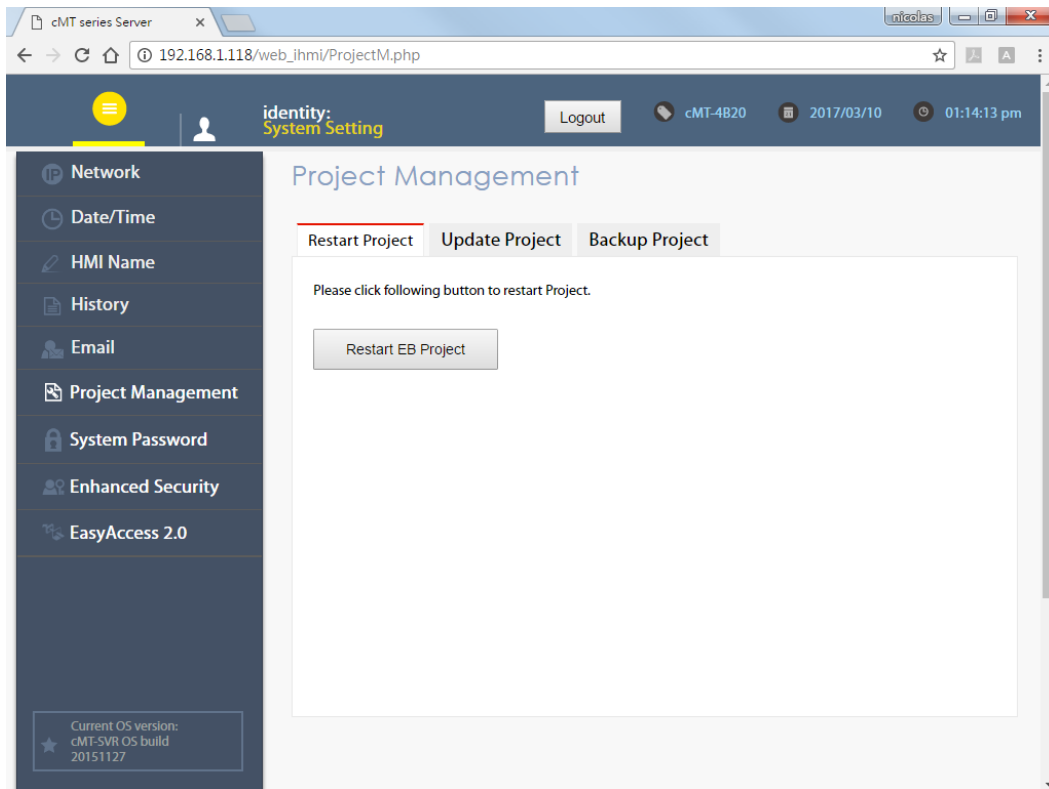

System Password

Set the password for login, and the password for transferring project file and history data.

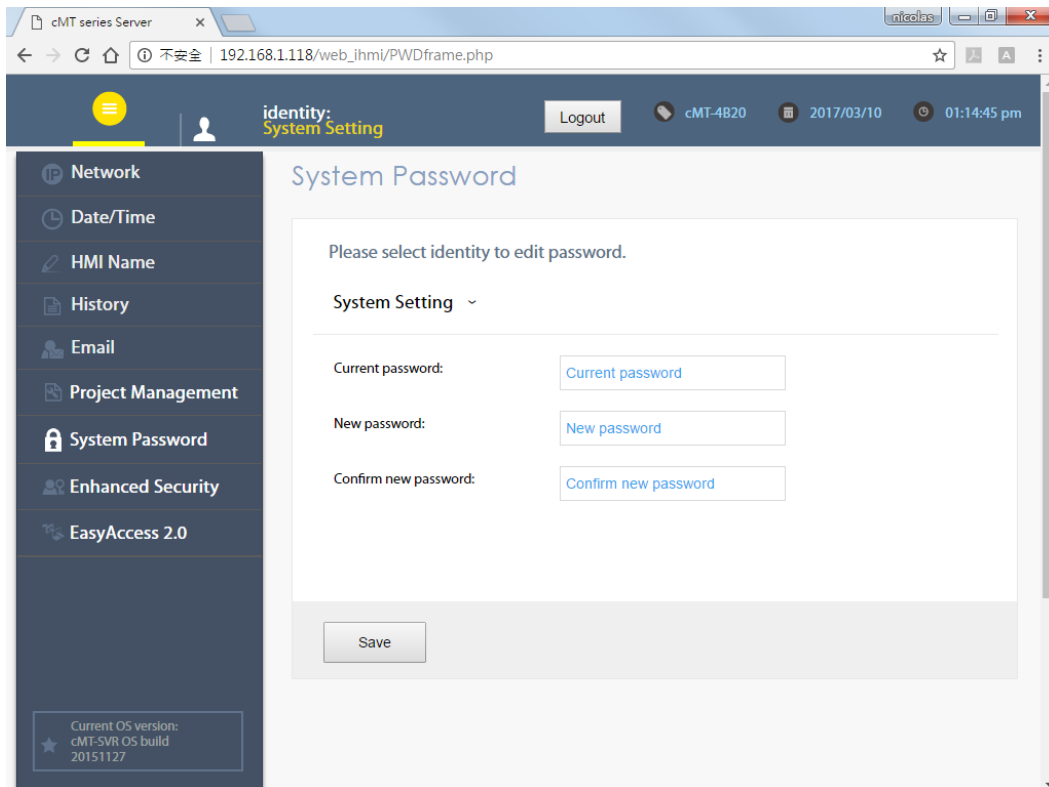

Enhanced Security

Set the privilege and password of the account.

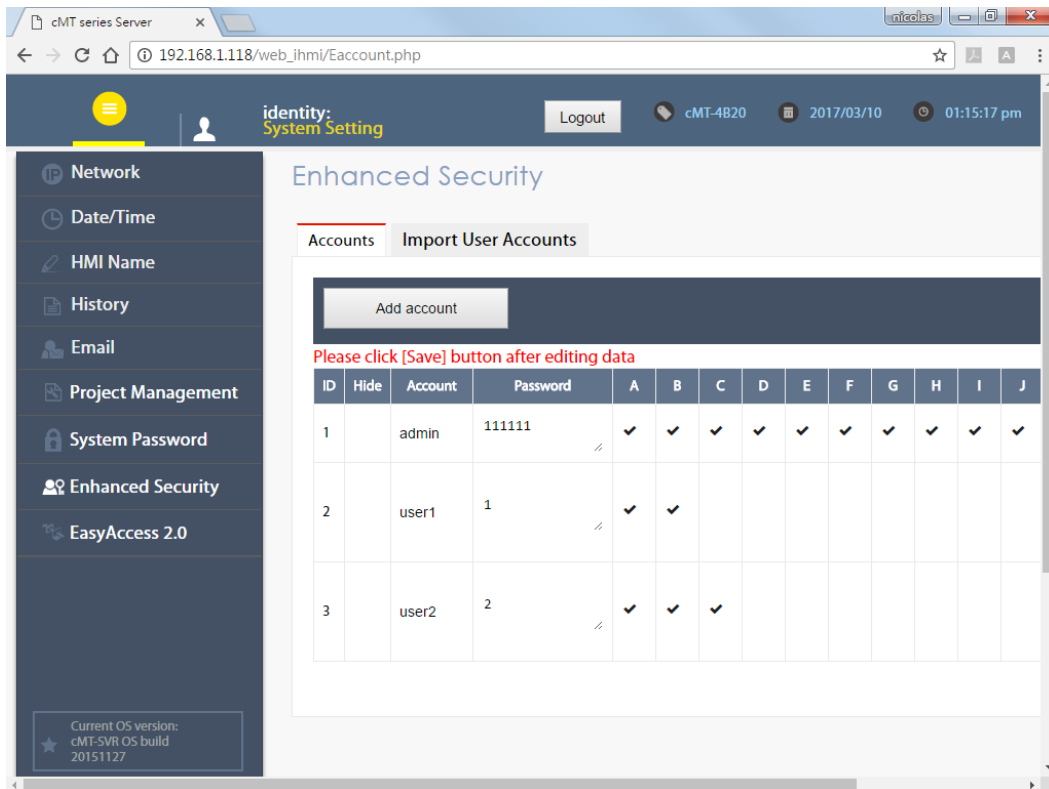

The screenshot shows the 'Enhanced Security' web interface. The left sidebar contains navigation options: Network, Date/Time, HMI Name, History, Email, Project Management, System Password, Enhanced Security, and EasyAccess 2.0. The main content area is titled 'Enhanced Security' and has two tabs: 'Accounts' (selected) and 'Import User Accounts'. Below the tabs is an 'Add account' button and a red warning message: 'Please click [Save] button after editing data'. A table lists three user accounts with columns for ID, Hide, Account, Password, and permissions A through J.

ID	Hide	Account	Password	A	B	C	D	E	F	G	H	I	J
1		admin	111111	✓	✓	✓	✓	✓	✓	✓	✓	✓	✓
2		user1	1	✓	✓								
3		user2	2	✓	✓	✓							

EasyAccess 2.0

Activate EasyAccess 2.0 and configure proxy settings.

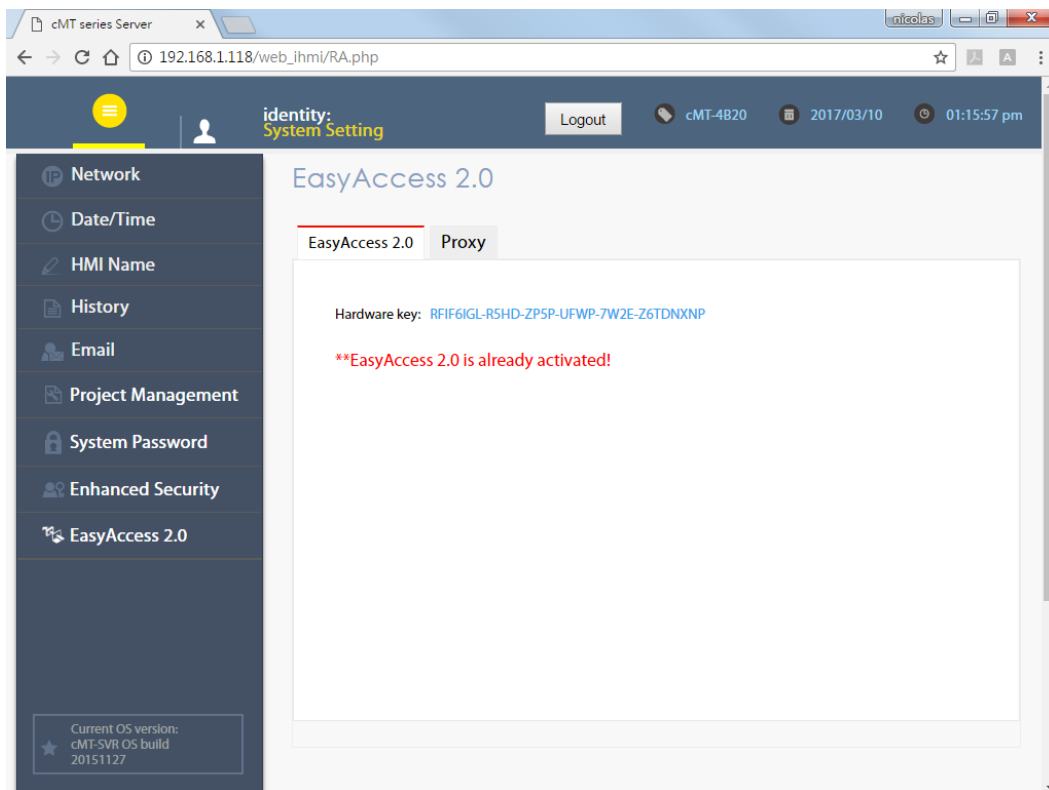

The screenshot shows the 'EasyAccess 2.0' web interface. The left sidebar is the same as in the previous screenshot. The main content area is titled 'EasyAccess 2.0' and has two tabs: 'EasyAccess 2.0' (selected) and 'Proxy'. Below the tabs, the hardware key is displayed: 'Hardware key: RFIF6IGL-R5HD-ZP5P-UFWP-7W2E-Z6TDNXP'. A red message states: '**EasyAccess 2.0 is already activated!'.

Misc

Miscellaneous settings.

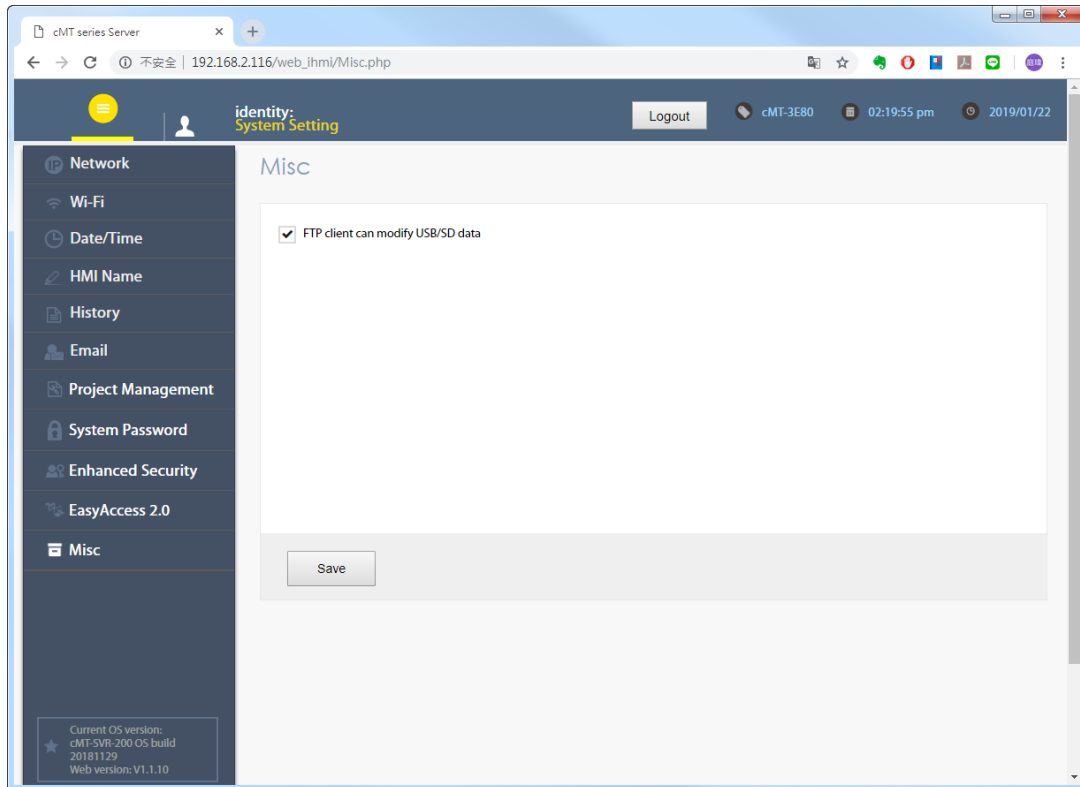

Chapter 3 How to create a cMT-SVR project

3.1 Create a new project

Step 1. Launch EasyBuilder Pro and select cMT-SVR model.

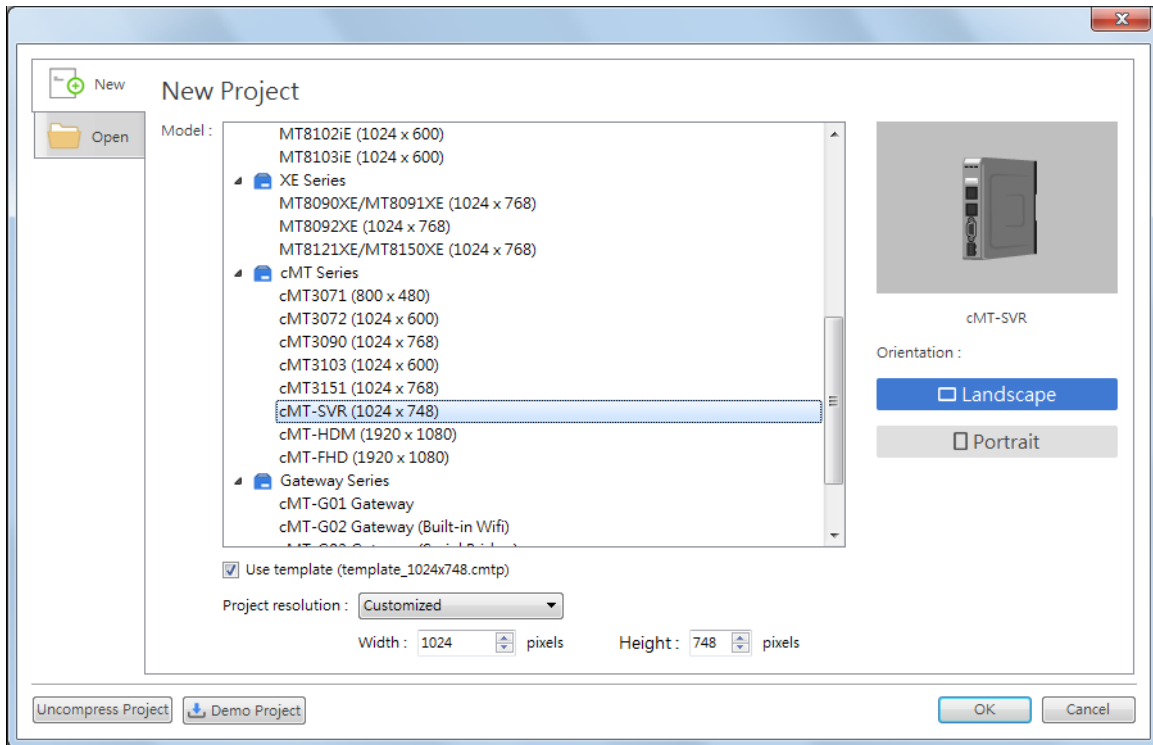

Step 2. Create the needed objects on editing screen.

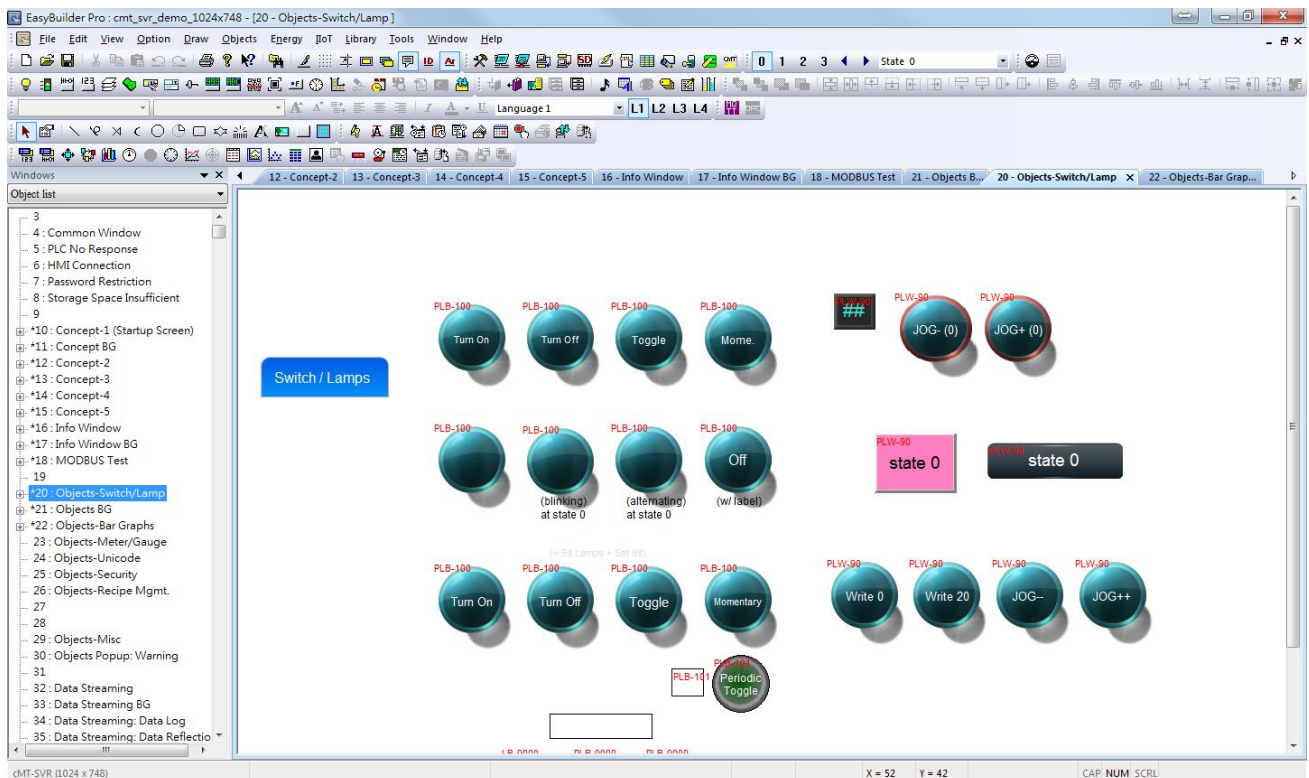

Step 3. Save the project and compile to *.cxob file.

3.2 Download project to cMT-SVR

After compilation, a *.cxob file is generated. The file can be downloaded via Ethernet in EasyBuilder Pro.

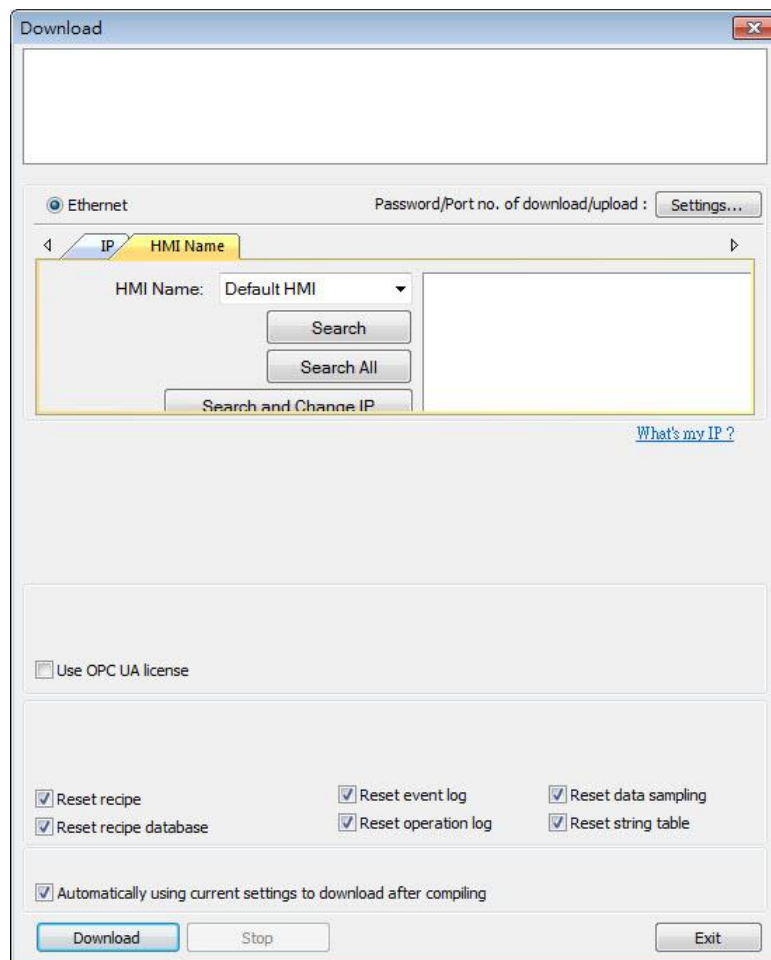

Or, in cMT-SVR System setting, tap Project Management \ Update Project to transfer the project file from PC to cMT-SVR. Open internet browser (IE, Chrome, Firefox), enter cMT-SVR IP address (for example: 192.168.1.118/web_ihmi), tap System setting, enter password, and then configure cMT-SVR settings.

Chapter 4 cMT Viewer App



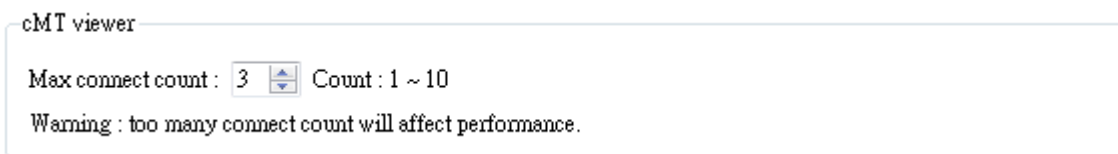

cMT Viewer can connect and control cMT Series HMI models. The devices that support cMT Viewer are: cMT-iV5 (Built-in), iPad/iPhone (Download from iOS® APP Store), Android™ (Download from Google Play), Windows® (in EasyBuilder Pro installation directory).

Please note that:

1. Each cMT Viewer device can simultaneously connect with 4 cMT Series models.
2. Each cMT Viewer device can simultaneously monitor 50 cMT Series models (under Monitor Mode).
3. Each cMT Series model can simultaneously connect with 1~10 cMT Viewer devices. In EasyBuilder Pro, open System Parameters » Remote and set [Max. connect count].



4.1 Introduction of icons

Icon	Description
	Tap this icon to run cMT Viewer App.
	Tap the Start Button when running the project to return to cMT Viewer home screen.
	Tap this icon to configure cMT Viewer.
	Tap this icon to change screen layout in Monitor Mode.
	Tap this icon to search for all cMT Series HMIs on the same network.

4.2 How to load project file to cMT Viewer

Step 1. Launch cMT Viewer App and tap the + button as shown below.

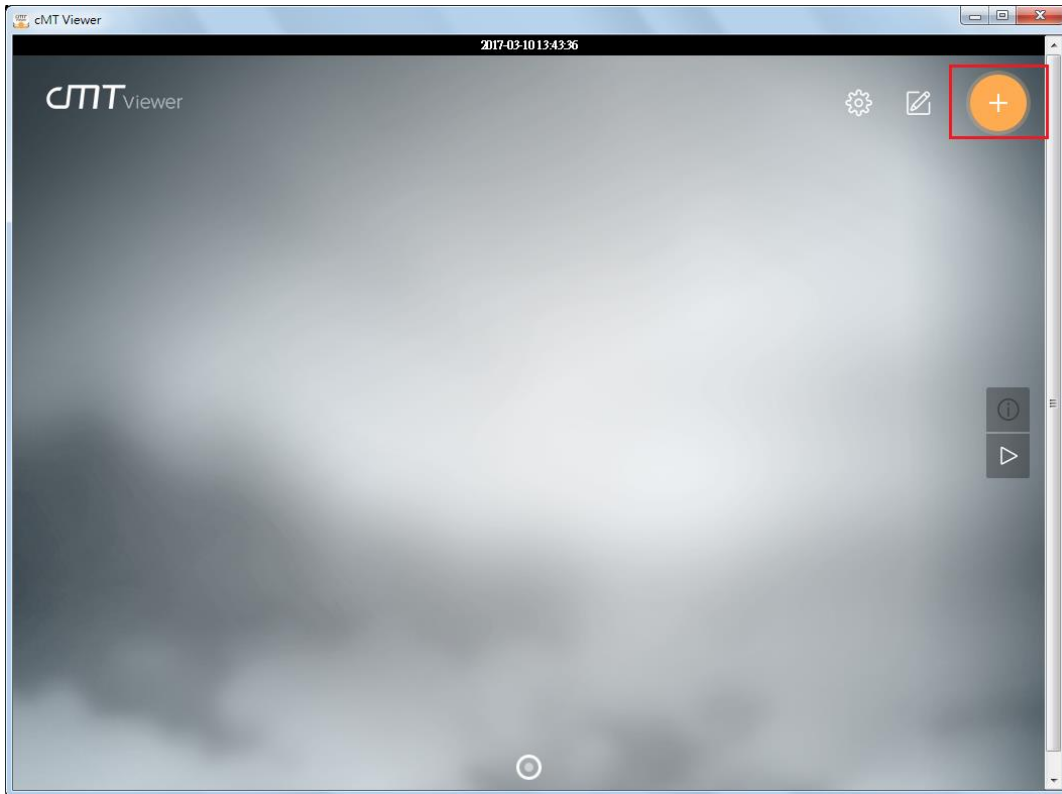

Step 2. Search for all the cMT Series HMI on the same network.

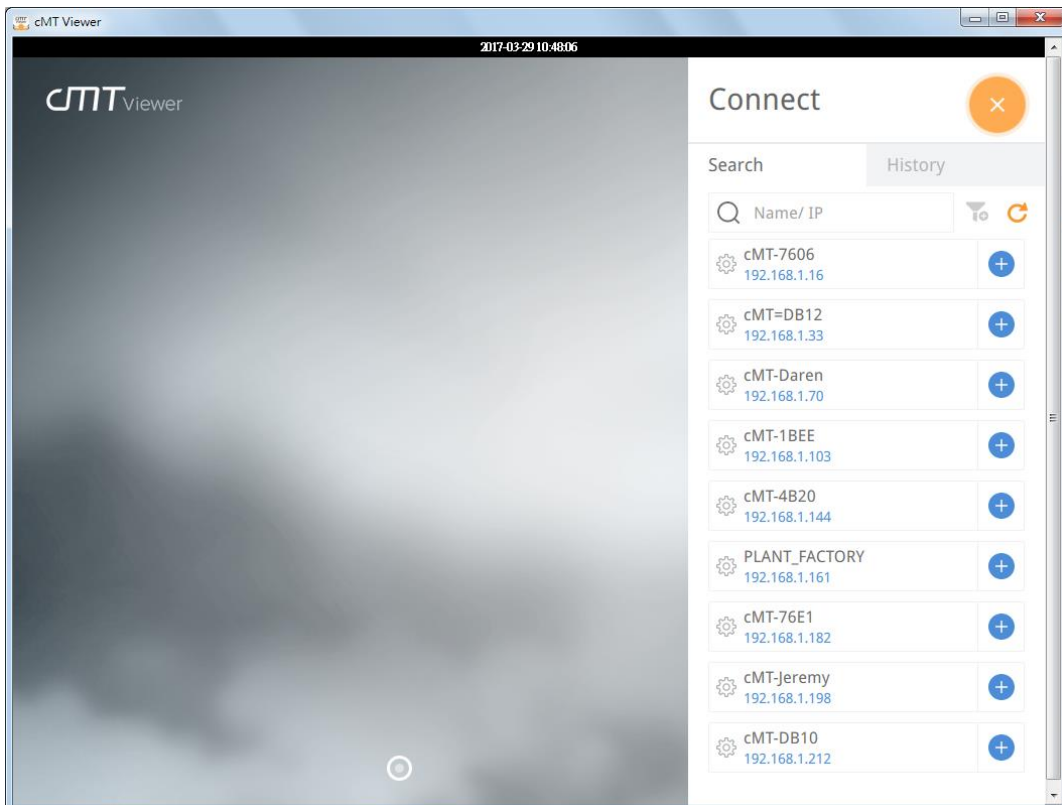

Step 3. Select a cMT Series HMI, tap  and then enter password. If [Use the same password for other machines] checkbox is selected, entering password will not be necessary when adding other cMT Seires HMI that uses the same password.

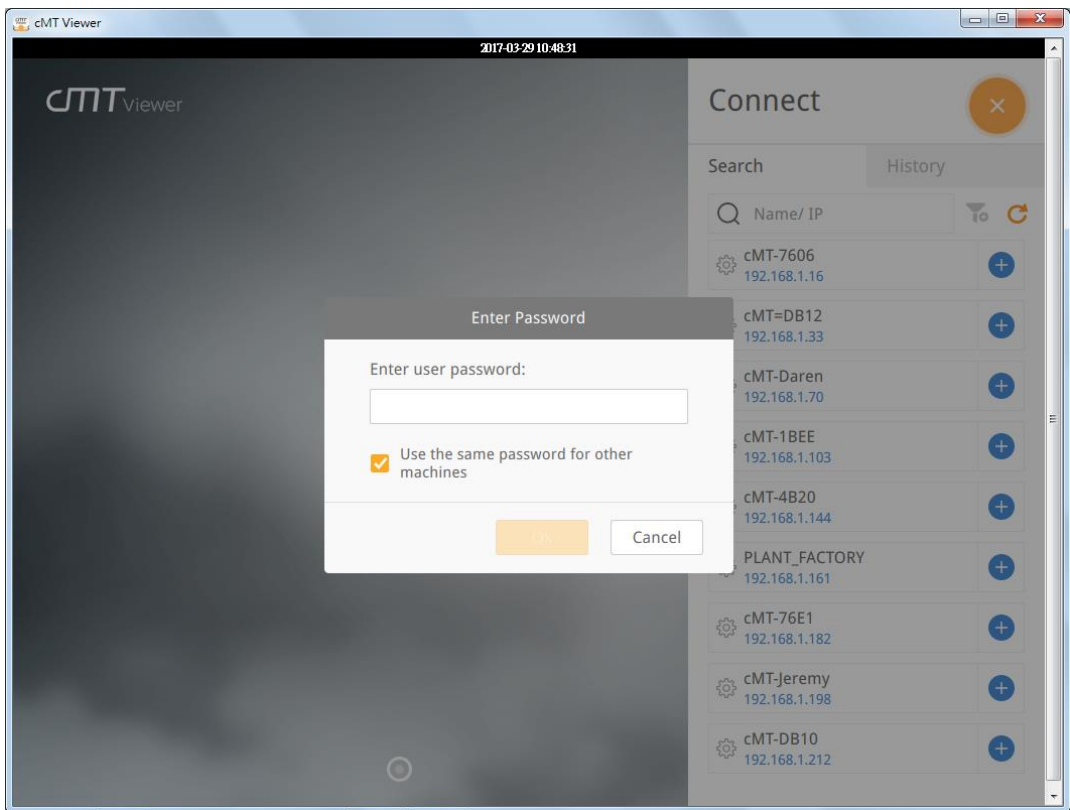

Step 4. When finished, cMT Viewer will display the project.

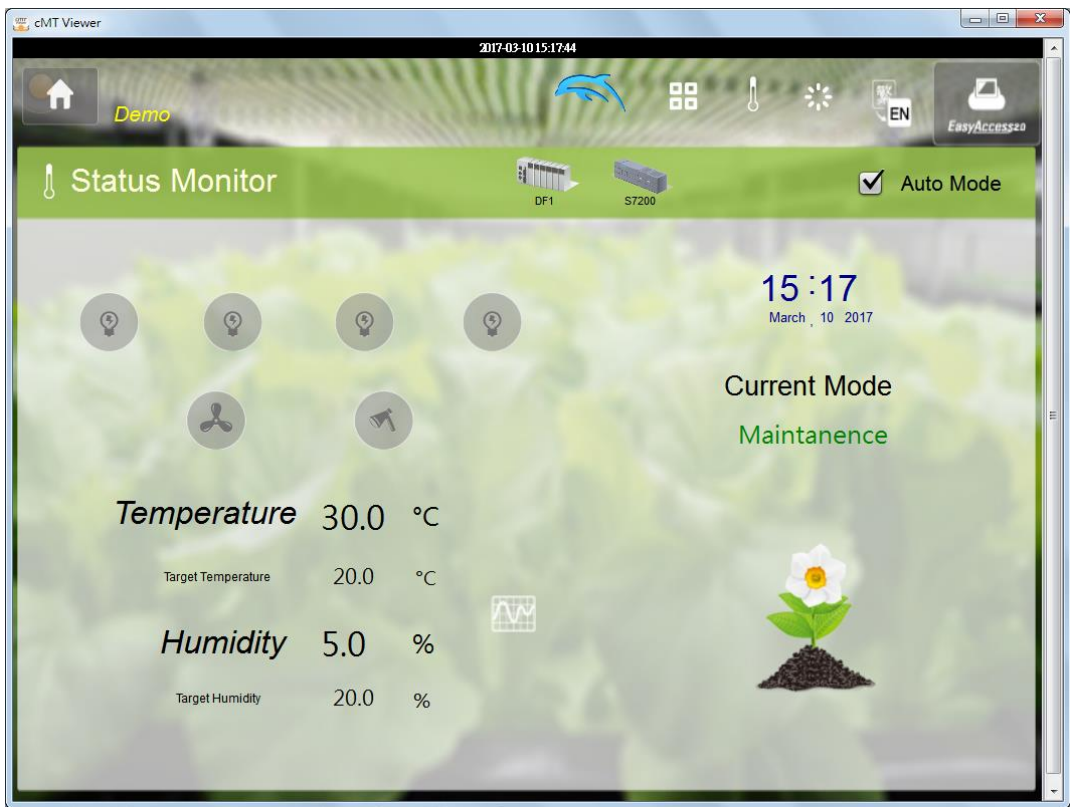

Tap Start Button to return to main screen. To connect another cMT-SVR, follow the preceding steps to search for cMT-SVR and load the project. The + button of the connected cMT Series

HMI will turn grey: 

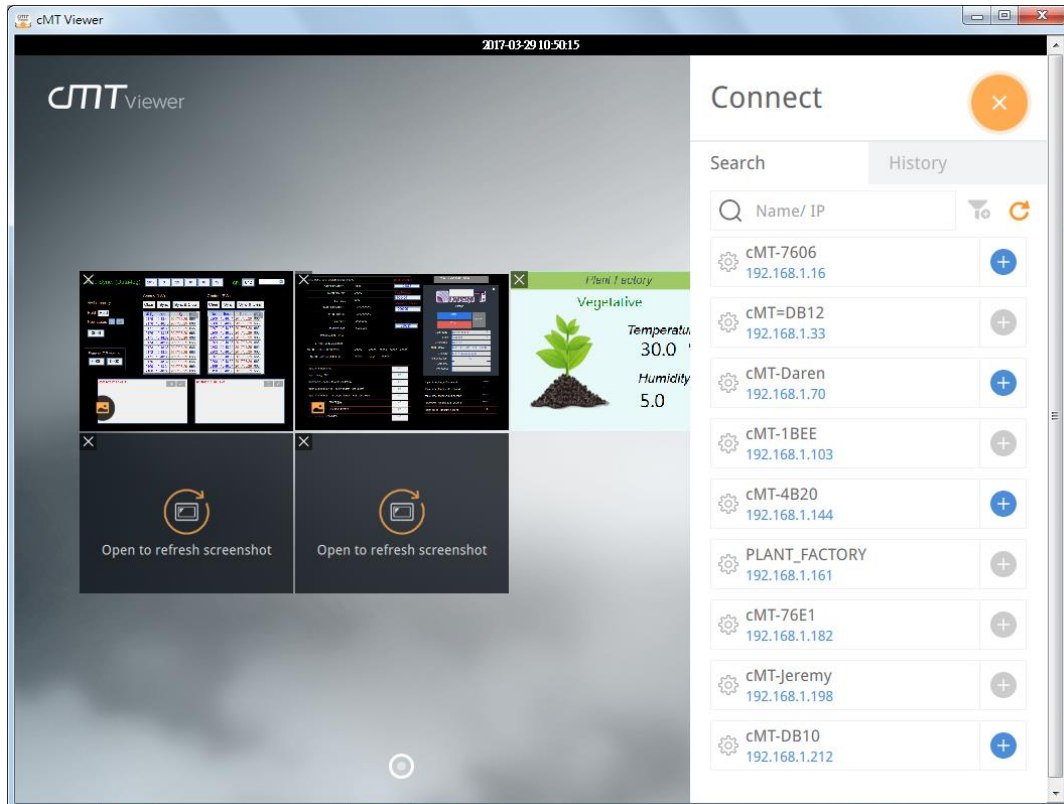

4.3 How to open cMT Viewer settings page

Step 1. In cMT Viewer main screen tap  icon.

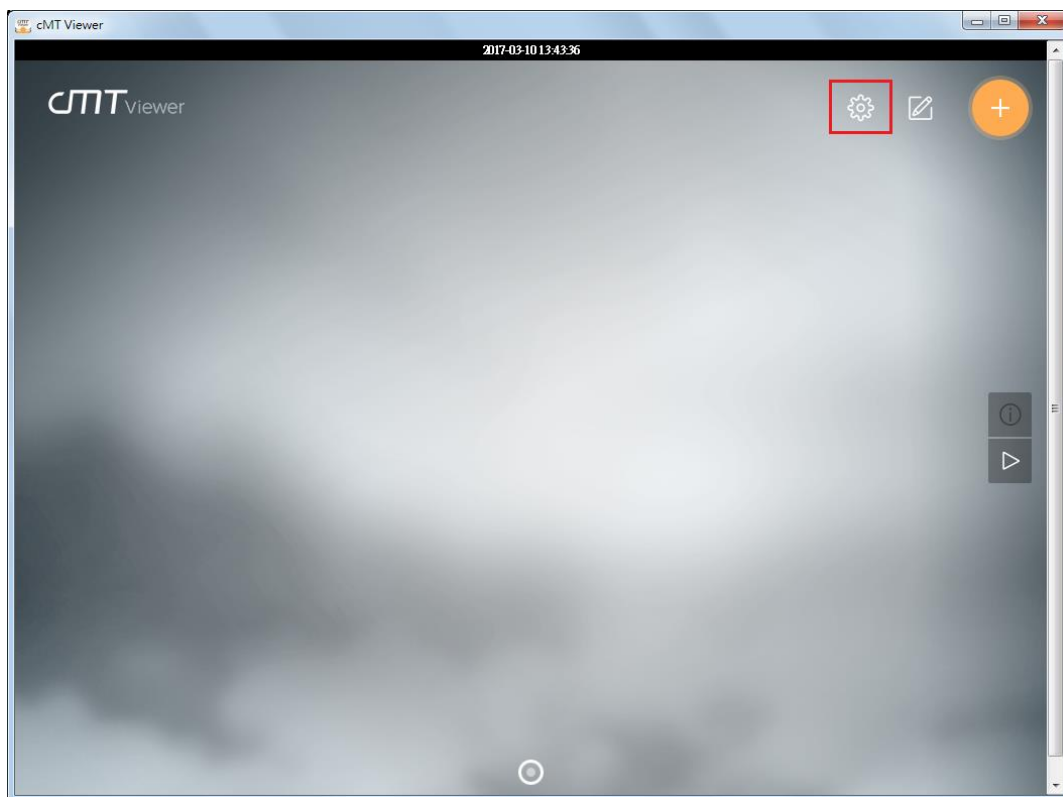

Step 2. Enter password to open [more settings].

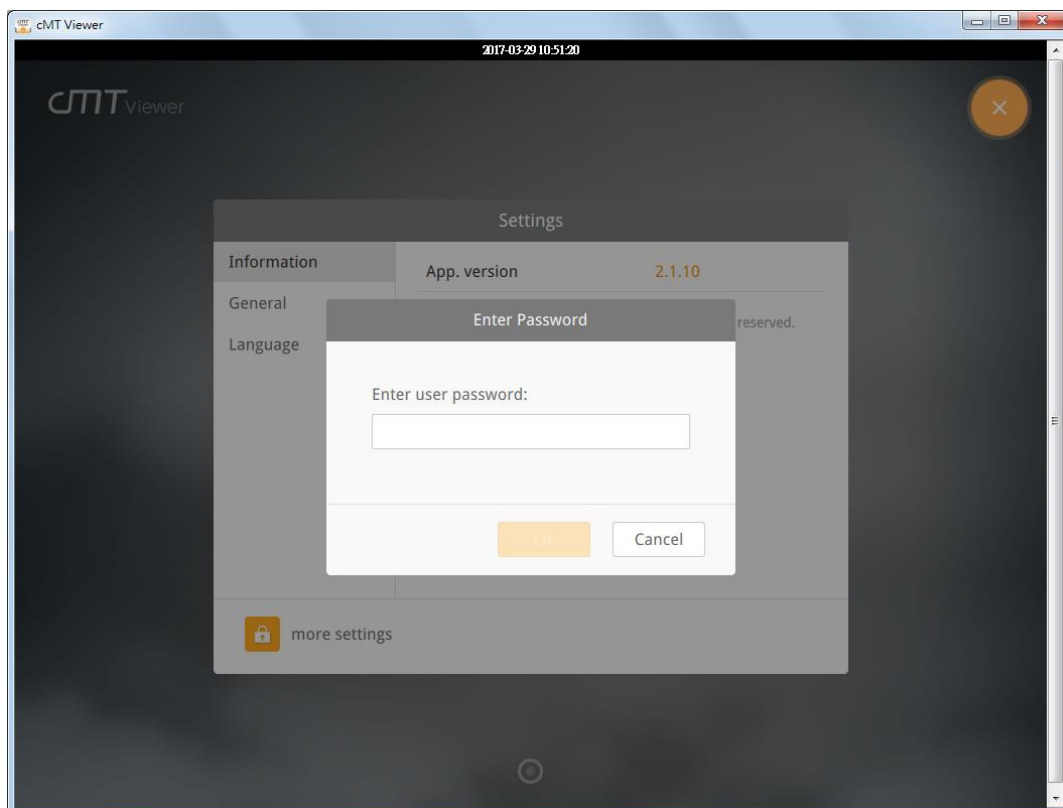

Information

cMT Viewer version information.

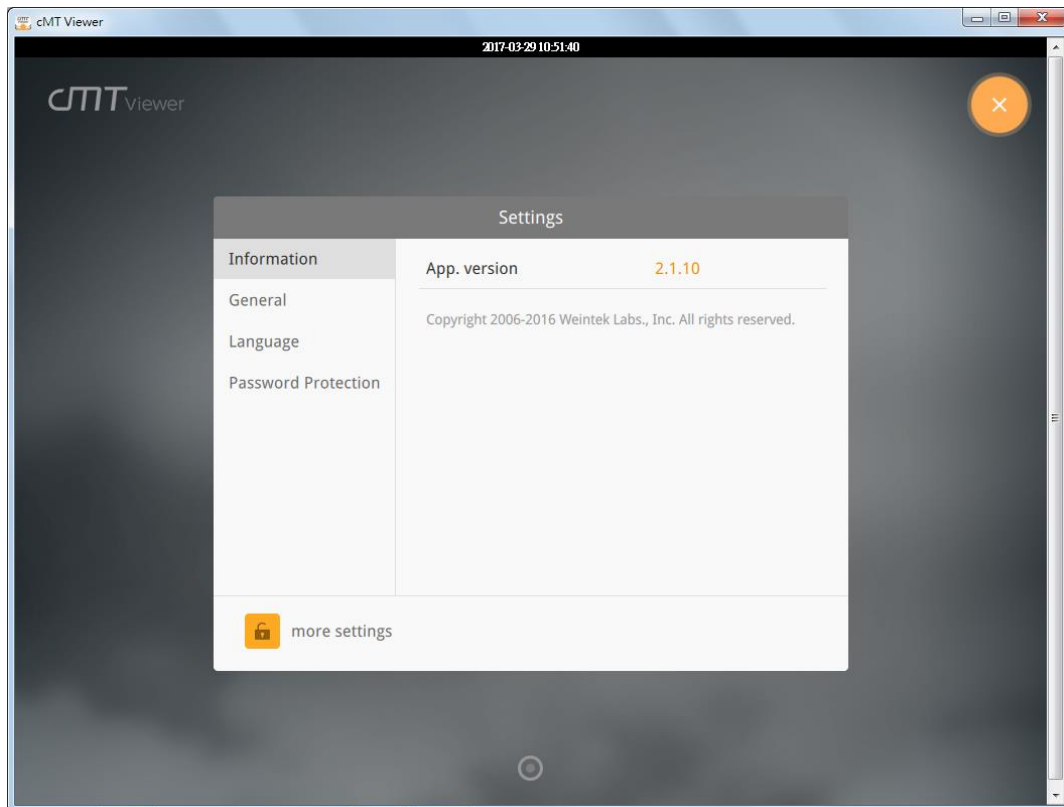

General

cMT Viewer display settings.

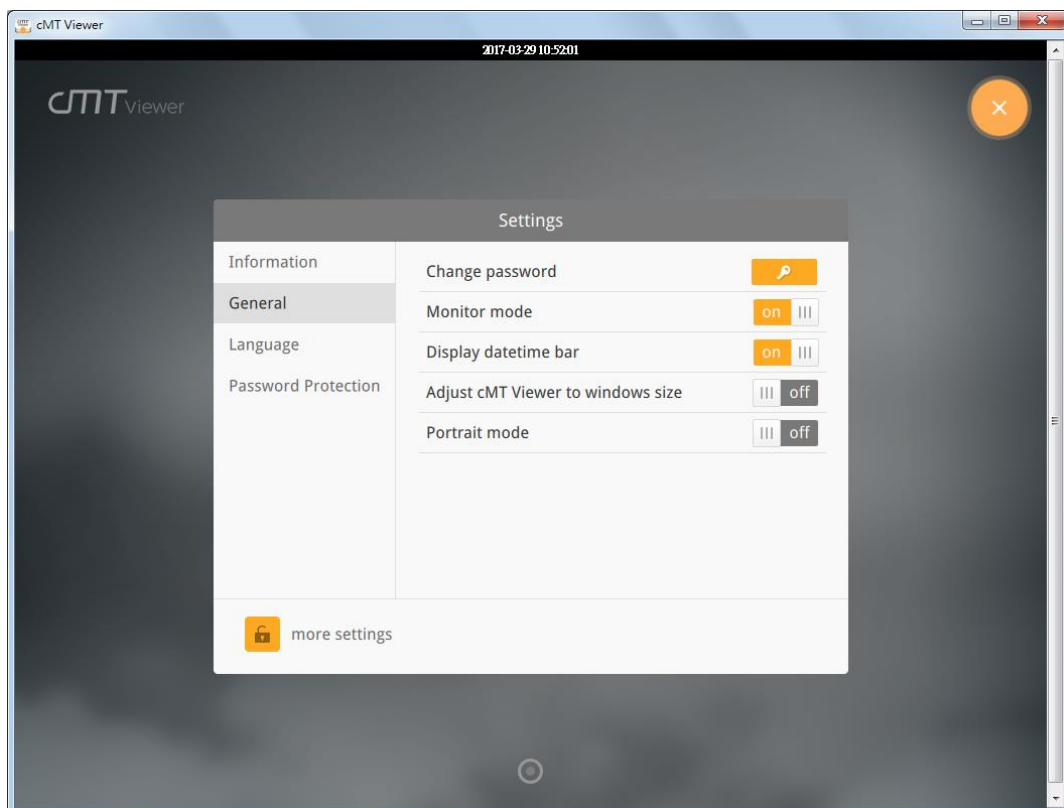

Language

cMT Viewer interface language menu.

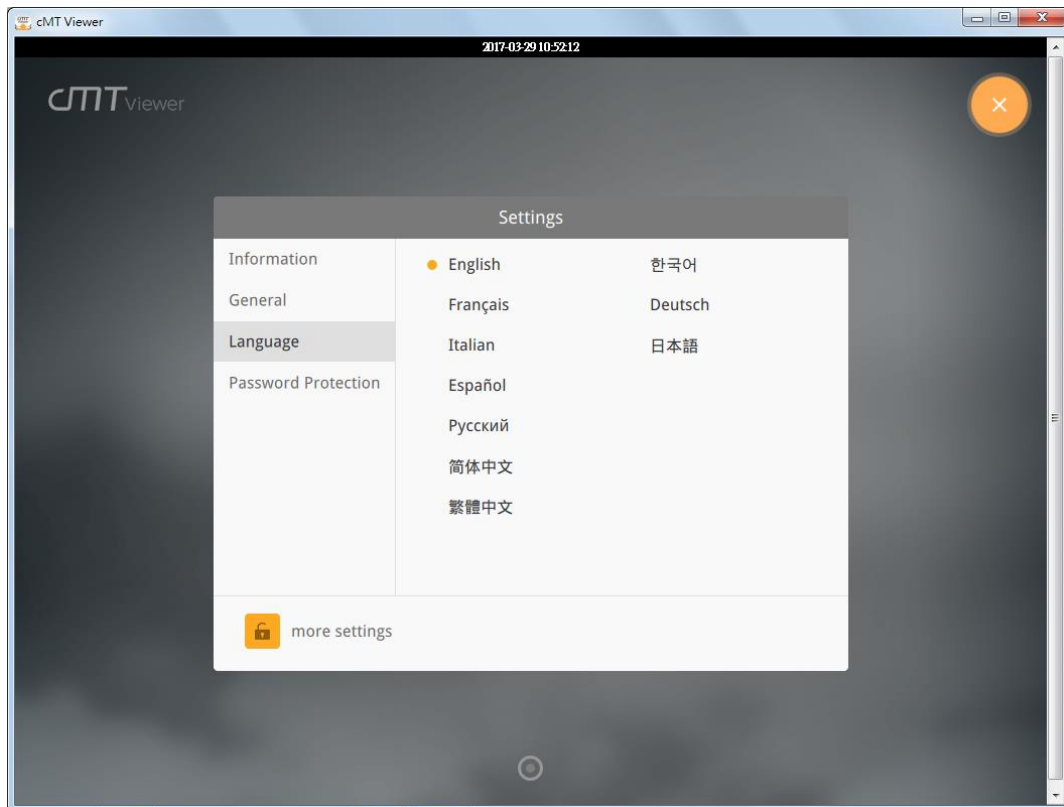

Password Protection

After setting, entering password will be necessary for using these functions.

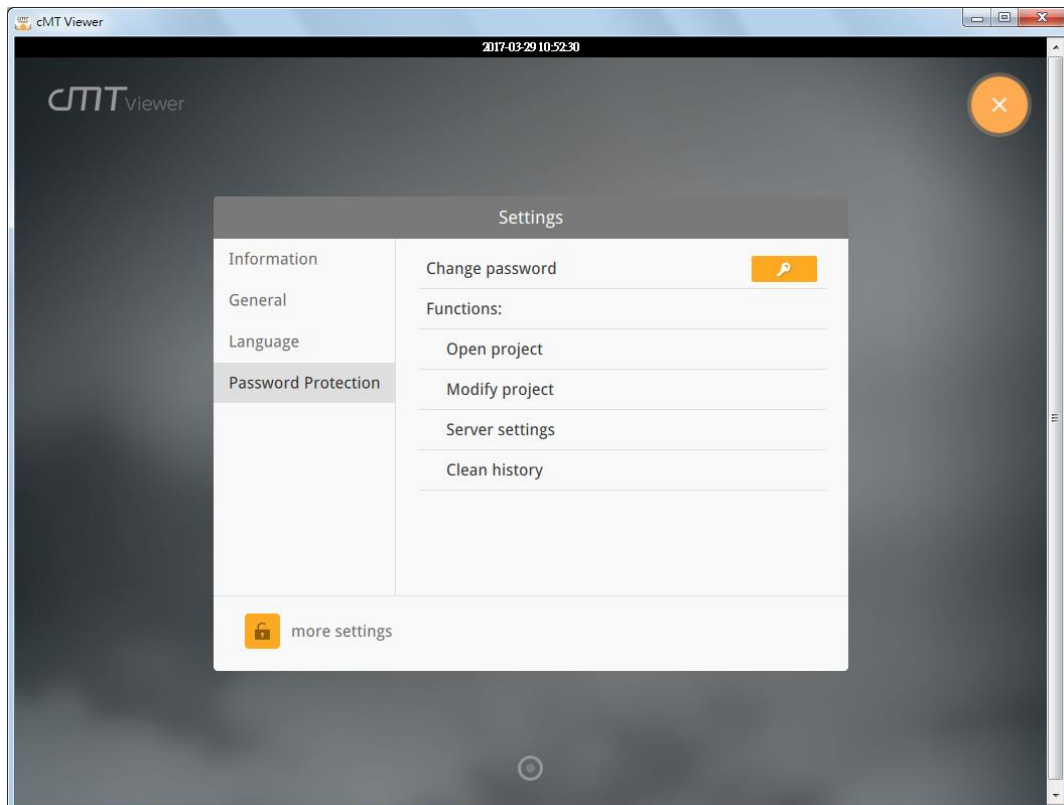

Open project

If this function is protected by password, adding new cMT Series HMI will require password.

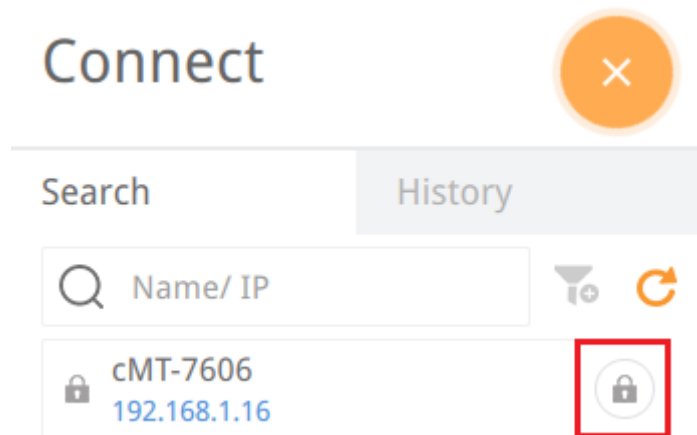

Modify project

If this function is protected by password, changing layout of Monitor Mode will require password.

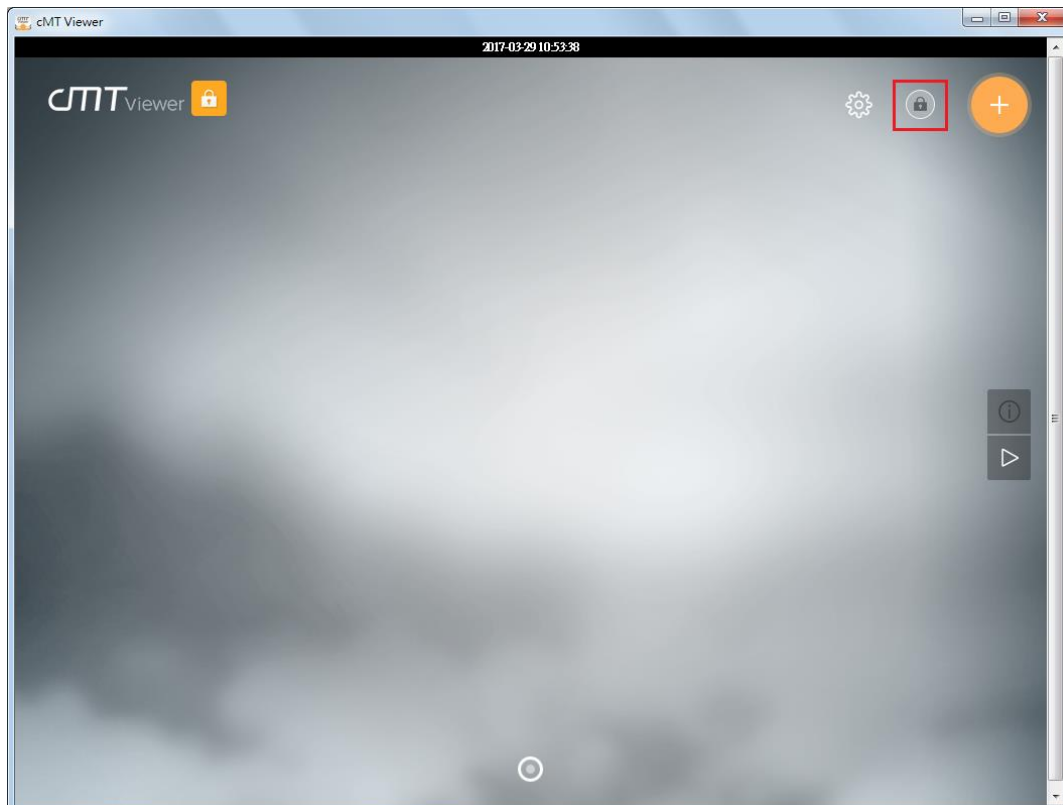

Server settings

If this function is protected by password, entering cMT system settings using cMT Viewer will require password.

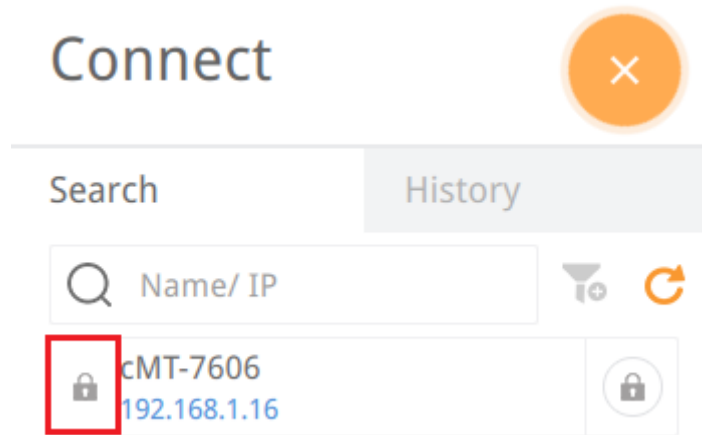

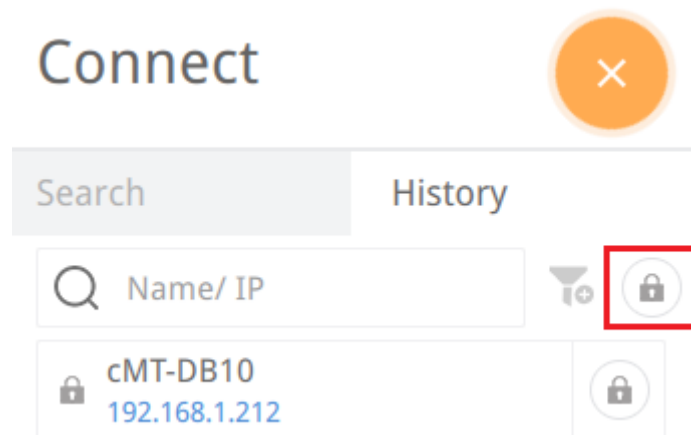

Clear history

If this function is protected by password, clearing connection history in History page will require password.

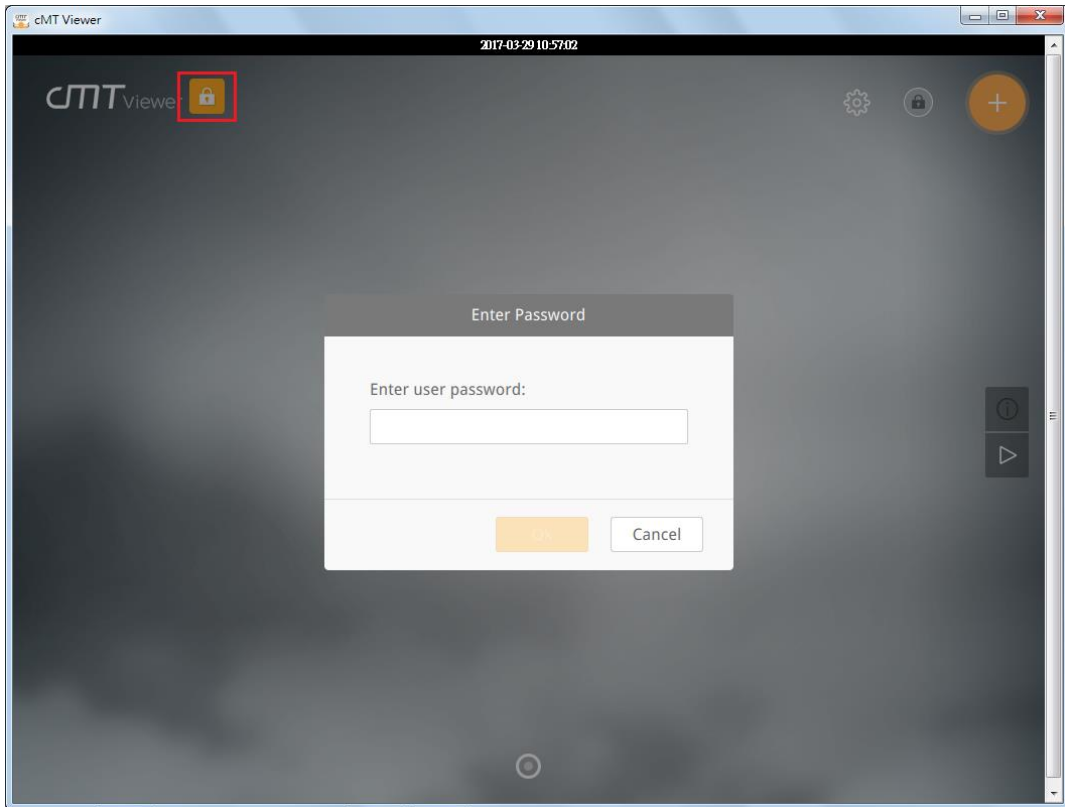

To use password protected functions, tap the lock icon  in the upper left corner and enter password.



After entering password, cMT Viewer will start a countdown timer of 10 minutes, when it's over, the functions protected by password will be locked again. The countdown timer can be reset by tapping any button in cMT Viewer. To reset the timer to zero, tap .

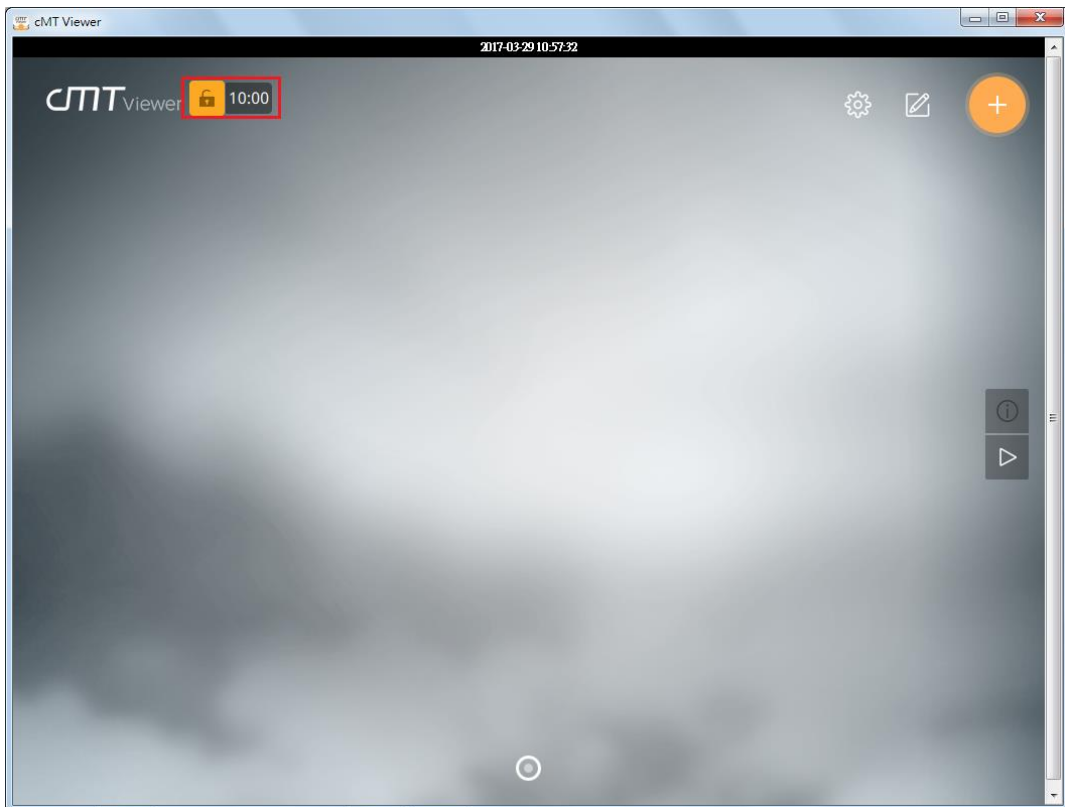

4.4 Monitor Mode

cMT Viewer supports Monitor Mode. By placing objects in Window no. 3 in the project, cMT Viewer screen can be refreshed dynamically. In Monitor Mode, the user can select up to 50 HMIs to monitor simultaneously, without the need for accessing each cMT.

Step 1. Enable Monitor Mode in EasyBuilder Pro » System Parameter Settings » General tab.

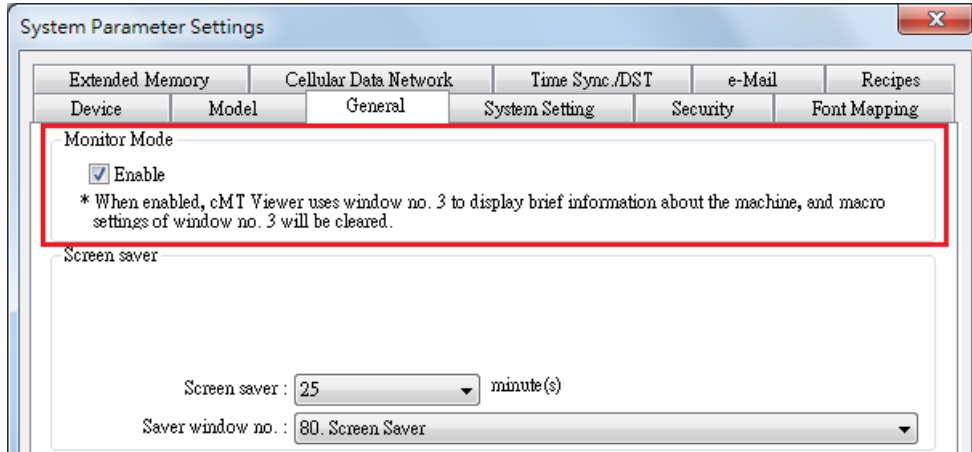

Step 2. Add the needed objects in Window No. 3, which is the Monitor Mode window by default.

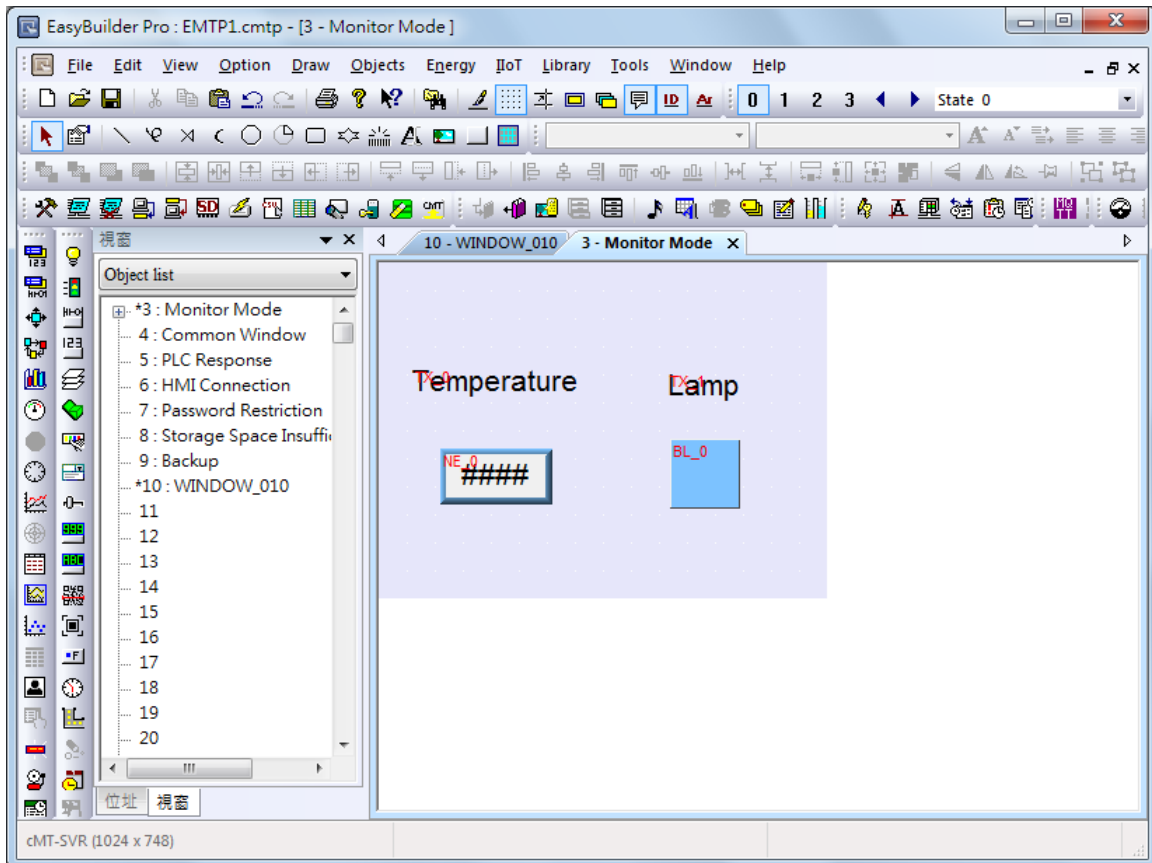

Step 3. Open [more settings] in cMT Viewer, go to General page and enable [Monitor mode].

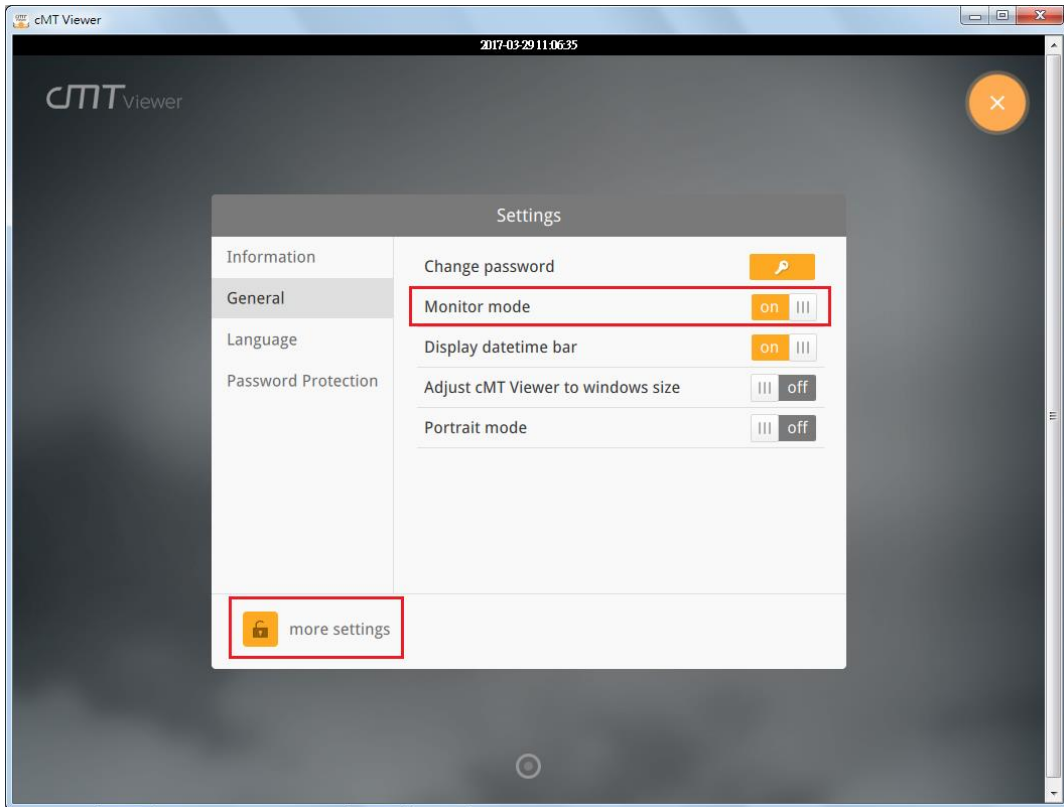

Step 4. Download the project file to cMT Series HMI using cMT Viewer, the Monitor Mode window appears.

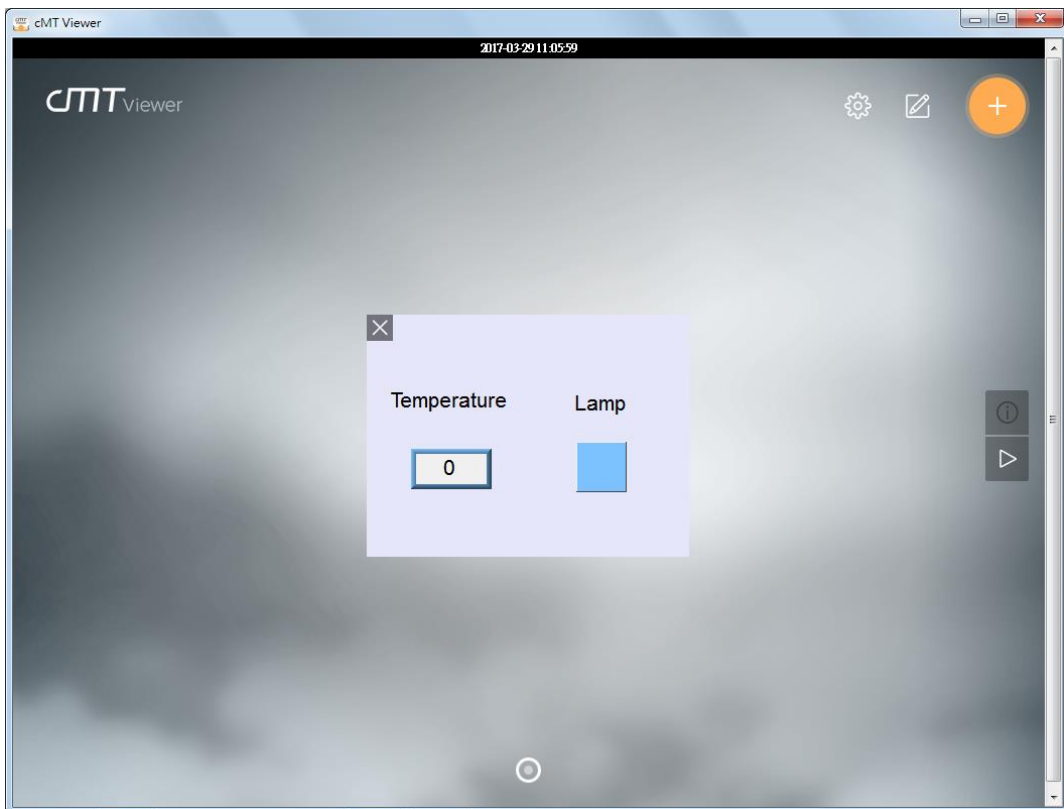

Windows is a trademark or a registered trademark of Microsoft Corporation in the United States and/or other countries.
 Android is a trademark or a registered trademark of Google, Inc. in the United States and/or other countries.
 IOS is a registered trademark of Cisco Systems, Inc. and/or its affiliates in the United States and certain other countries.
 Intel Atom is a trademark of Intel Corporation or its subsidiaries in the U.S. and/or other countries.
 Other company names, product names, or trademarks in this document are the trademarks or registered trademarks of their respective companies.
 This document is subject to change without prior notice.